



DRAIN CLEANING

- Wide selection from a single source – "The Right Machine for Every Job".
- A legacy of innovation and quality.

Type	No. of Models	Length (ft.)	Page
Hand Tools			
Toilet/Urinal Augers	4	3-6	14.6-14.7
Grapppler Hook	1	6	14.8
Flat Sewer Tape	10	25-100	14.8
Hand Spinners	4	25-35	14.9-14.10
Sink Machines			
PowerClear™	1	30	14.11
K-40/K-45	18	25-35	14.11-14.14
Drum Machines			
Up to 4" Capacity	12	50-100	14.15-14.18
Up to 6" Capacity	3	50-200	14.19-14.20
Up to 8" Capacity	10	25-200	14.21-14.22
Up to 10" Capacity	9	25-250	14.23-14.24
Open Bale Drum Machines			
Up to 6" Capacity	1	100	14.25-14.26
Sectional Machines			
Up to 4" Capacity	16	Up to 175	14.27-14.30
Up to 8" Capacity	12	Up to 200	14.31-14.34
Up to 10" Capacity	11	Up to 300	14.35-14.38
Rodder Machines			
Up to 24" Capacity	2	Up to 500	14.39-14.40
Water Jetting Machines			
Up to 4" Capacity	4	25-200	14.41-14.42
Up to 6" Capacity	2	50-200	14.43-14.44
Up to 10" Capacity	2	35-300	14.45-14.46

HAND TOOLS



	Page
Augers	14.6
Grapple Hook	14.8
Flat Sewer Tape	14.8
Hand Spinners	14.9-14.10

SINK MACHINES

Easily portable, compact and lightweight.



Application	Model	Page
Bathroom/lavatory/kitchen sinks, tub/shower, urinal and laundry tub drains	PowerClear	14.11
	K-40	14.11
	K-45	14.13

DRUM MACHINES

Delivers high torque to clear obstructions

- Power and torque.
- Cable-saving features.
- Superior maneuverability.



Application	Model	Page
Bathroom/lavatory/kitchen sinks, tub/shower, urinal, laundry tub, roof vents and indoor floor drains	K-400	14.15
Bathroom/lavatory/kitchen sinks, tub/shower, urinal, laundry tub, roof vents and indoor floor drains	K-3800	14.17
House laterals/main drains/floor drains	K-6200	14.19
Laterals, main lines, commercial lines	K-750	14.21
	K-7500	14.23
	K-750R	14.25

SECTIONAL MACHINES



High-speed cutting action to drill through obstructions.

- Power and speed with cable control.
- Lightweight and portable.

Line Size	Application	Model	Page
3/4" to 4"	Bathroom/lavatory/kitchen sinks, tub/shower, urinal, laundry tub, roof vents and indoor floor drains	K-50	14.27
1 1/4" to 4"	Sink lines, roof vents and floor drains	K-60SP	14.29
2" to 8"	Roof vents, floor/secondary lines, laterals and main lines	K-5208	14.31
2" to 8"	Floor/secondary lines, laterals and main lines	K-1500	14.33
2" to 10"	Laterals and main lines, commercial lines	K-1500SP	14.35
2" to 10"	Laterals and main lines, commercial lines – gasoline engine powered for remote locations	K-1500G	14.37

RODDER MACHINES



Designed specifically for larger diameter lines.

Line Size	Application	Model	Page
8" to 24"	Straight main work in municipalities, universities, institutions and industry	K-1000	14.39





WATER JETTERS







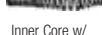
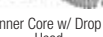

Water jetting machines are ideal for clearing grease, sludge or soap-clogged lines.

Line Size	Application	Model	Page
1 1/4" to 4"	Sink lines/floor/secondary lines	KJ-1350	14.41
		KJ-1750	14.42
1 1/4" to 6"	Sink lines/floor/secondary lines/laterals	KJ-2200	14.43
2" to 10"	Sink lines/floor/secondary lines/laterals/main lines	KJ-3100	14.45









For Drain Guns, Sink Drums, and Small Line Sectional Machines











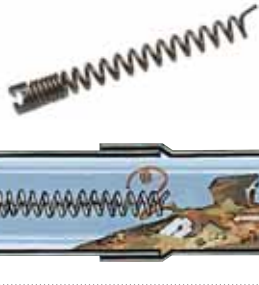
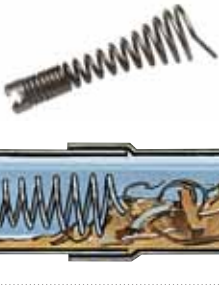



	Model	Length	Typical Application	Characteristics	Machines
5/16" (8mm)	 Bulb Auger C-1 C-21	25' 50'	Drain Lines 3/4" to 1 1/2". Kitchen Sinks, Lavatory Sinks, Bathtub Drains, Drinking Fountains and Urinals.	Hollow core cables that provide maximum flexibility for severe bends and "P" Traps.	K-25/K-26 (25' only) K-45 K-40 K-50
	 Drop Head C-2 C-22	25' 50'	Drain Lines 3/4" to 1 1/2". Drop Head leads into down drain pipes, especially good for back-to-back mounted fixtures and severe bends.		
	 Inner Core w/ Bulb Auger C-11C C-131C	25' 35'	Drain Lines 1 1/4" to 2". Kitchen Sinks, Lavatory Sinks, Slop Sinks and Laundry Lines.	Inner core cables that provide good flexibility while resisting kinking.	K-25/K-26 (25' only) K-45, K-40 K-3800, K-50
	 Inner Core w/ Drop Head C-21C C-231C	25' 35'	Drop Head leads into down drain pipes, especially good for back-to-back mounted fixtures and severe bends.		
3/8" (10mm)	 Male Coupling C-4 C-6 C-61C	25' 35' 35'	Drain Lines 1 1/4" to 2 1/2". Kitchen Sinks, Lavatory Sinks, Slop Sinks, and Disposal Waste Lines.	Flexible, yet tough 3/8" cable most commonly used after traps have been removed. C-61C slightly stiffer than C-6.	K-45 K-40 K-50
	 Bulb Auger C-5	35'	Drain Lines 1 1/4" to 2 1/2". Kitchen Sinks, Lavatory Sinks, Slop Sinks, and Disposal Waste Lines.		

For Drum Machines

	Model	Length	Typical Application	Characteristics	Machines
3/8" (10mm)	 w/Inner Core C-31, C-31W C-32, C-32W C-33, C-33W	50' 75' 100'	Drain Lines 1 1/2" to 2 1/2". Kitchen Sinks, Lavatory Sinks, Slop Sinks and Laundry Stacks.	Good flexibility. As torque builds, outer spring tightens on wire core causing cable to stiffen and transfer greater torque to cutter.	K-400 K-3800
1/2" (12mm)	 w/Inner Core C-44, C-44W C-45, C-45W C-46	50' 75' 90'	Drain Lines 2" to 4". Laundry Stacks, Roof Vents and Indoor Floor Drains.	Same characteristics as above. Exceptional flexibility and toughness for a 1/2" inner core cable.	K-400 K-3800
5/8" (16mm)	 w/Inner Core C-25, C-25HD C-26, C-26HD C-27, C-27HD C-24, C-24HD	25' 50' 75' 100'	Drain Lines 3" to 6". Floor Drains, Vents, and Laterals.	General purpose cable. Inner core provides greater stiffness under load.	K-750 K-6200 K-7500
	 w/Hollow Core C-27HC C-24HC	75' 100'	Drain Lines 3" to 6". Floor Drains, Vents, and Laterals.	Hollow core cable is lighter in weight & more flexible. Helps operator negotiate difficult traps & bends in large lines.	K-750 K-7500
3/4" (20mm)	 w/Inner Core C-28 C-29 C-75 C-100	25' 50' 75' 100'	Drain Lines 4" to 10". Main Lines including Laterals.	Powerful cable used for heavy-duty blockages such as tree roots. Cable tightens on core to provide extra stiffness under load, delivering power to cutter.	K-750 K-7500
	 w/Hollow Core C-75HC C-100HC	75' 100'	Drain Lines 4" to 6". Main Lines including Laterals.	Hollow core cable is lighter in weight and more flexible. Helps operator negotiate difficult traps and bends in large lines.	K-750 K-7500

For Sectional Machines

	Model	Length	Typical Application	Characteristics	Machines
5/8" (16mm)	 C-7	7 1/2'	2" and 3" Floor Drains.	Tight wind cable providing good rigidity in a hollow core cable. Not for tree roots.	K-50, K-60SP
	 C-8	7 1/2'	Drain Lines 1 1/4" to 2". Ideal for proper cleaning of small lines.	Open wind cable that is more flexible than C-7. Open wind acts as an auger to thoroughly remove blockages in small lines.	K-50, K-60SP
	 C-9	10'	Drain Lines 2" to 4". Ideal for Floor Drains and Stacks.	Heavy-Duty open wind cable ideal for long runs in indoor lines.	K-50, K-60SP
7/8" (22MM)	 C-10	15'	Drain Lines 2" to 4". Rooftop Vent Stacks.	Standard all-purpose open wind. Excellent flexibility.	K-60SP K-1500A/B K-5208
1 1/4" (32mm)	 C-11	15'	Drain Lines 3" to 8". Good for all around work. Easily negotiates 4" Traps.	Standard all-purpose open wind with 3/8" pitch. Flexible, yet rigid enough to do fast, tough root cutting.	K-1500A/B/ SP K-5208
	 C-12	15'	Drain Lines 4" to 10". Do not use through 4" "P" Traps.	Extra-heavy-duty open wind with 3/8" pitch. Designed for 4" to 10" long runs.	K-1500A/B/ SP K-5208
	 C-14	15'	Drain Lines 3" to 10". Do not use through 4" "P" Traps.	Heavy-duty open wind with 1/2" pitch. Especially good For 4" cleanout or 8" elbow entering in 4" to 10" line.	K-1500A/B/ SP K-5208
	 C-15	15'	Drain Lines 3" to 6". Ideal for 4" Traps.	Extra-flexible open wind with 1/2" pitch. Lighter than C-11, slightly stiffer.	K-1500A/B K-5208

<p>Drop Head Auger For cleaning back to back mounted fixtures e.g., sinks where cable needs to be led into down pipe.</p> 	<p>Straight Auger For use in exploring and breaking up stoppages or returning sample to surface to determine correct tool.</p> 	<p>Funnel Auger For use as second tool in line. Breaks up remains of stoppage left by straight auger.</p> 	<p>Hook Auger For heavy and dense root stoppages in pipes that require hooking and breaking up.</p> 
<p>Retrieving Auger For searching for cable which is broken or lost in line.</p> 	<p>Spade Cutter For following up after augers have been used and to open up floor drains.</p> 	<p>Four Blade Saw Tooth Cutter For blockages caused by hardened, glazed material such as chemical deposits.</p> 	<p>Grease Cutter For lines which have become badly greased with detergents and have to be opened.</p> 
<p>Spiral Saw Tooth Cutter For clearing any stoppage, roots, rags, sticks, etc.</p> 	<p>Saw Tooth Cutter For cleaning lines blocked heavily with roots. Unique design permits cutter to be removed from damaged pipe without locking.</p> 	<p>Spiral Bar Cutter For main sewers blocked by roots, leaf debris, sticks, sawdust, cloth, and sacking.</p> 	<p>Sharktooth Cutter For use in cleaning pipes of general material clinging to pipe walls.</p> 
<p>Grease "C" Cutter For grease blockage in lines leading from garbage disposal unit or waste pipe.</p> 	<p>Expanding Finish Cutters For final removal of material adhering to walls and certain roots of fibrous nature.</p> 	<p>Chain Knocker For use when vigorous action is required for cleaning of scale in pipes and boiler tubes.</p> 	<p>Flue Brush For use for finish cleaning required of boiler tubes and heat exchangers.</p> 

(TOOLTIP)

Always start with a straight auger to determine what you are trying to clean. Then choose the correct cutter to clear the drain.

Toilet/Urinal Augers



K-1 COMBINATION AUGER

- The K-1 Combination Auger provides an all-in-one solution for removing blockages from urinals and shower drains.
- Dual Power Operation - provides additional power necessary for removing tough obstructions.
- Telescoping Design - provides additional cable length needed to remove obstructions further down the line.
- "C" Cutter Head - ideal for breaking up hard blockages.
- Left Hand Wound Cable - strengthens cable and prevents kinking.



SPECIFICATIONS

- Pipe Sizes Up to 2" (50 mm)
- Cable Length – 4 ft (1.2 m)
- Cable Diameter – 3/8" (10 mm)
- Operation – Manual or Drill Powered
- Applications – Urinals & Shower Drains
- Cutter Head Type – "C" Cutter

Catalog No.	Model No.	Description	Weight	
			lb	kg
46683	K-1	Combination Auger	5	2.3
48223	K-1 Cable	Rep Cable	2	0.90
48228	K-1 Blade	Rep Cutter	0.5	0.22



K-3 AND K-6 TOILET AUGERS

- High quality tools in 3' (1 m) and 6' (2 m) lengths provide fast and safe clearing of toilet obstructions.
- Vinyl guard protects porcelain.
- New durable, kink-resistant, 1/2" (12.7 mm) compression-wrapped Inner Core Cable.
- Large, ergonomically designed handles.
- Negotiate water-conserving toilets.

Catalog No.	Model No.	Description	Weight		Replac. Cables
			lb	kg	
59787	K-3	3' (1 m) Toilet Auger with Bulb Head	4.5	1.9	-
59802	K-6 DH	6' (2 m) Toilet Auger with Drop Head	5.5	2.5	60367



Toilet/Urinal Augers

NEW



K-6P TOILET AUGER

- Optional drill attachment to power through toilet obstructions.
- Quick lock adjustment to extend the cable 6' and clear beyond the toilet.
- Zinc plated steel tubing to resist corrosion.
- Heavy-duty Tri-Wrap cable for optimum strength.

Catalog No.	Model No.	Description	Weight		STD. PACK
			lb	kg	
56658	K-6P	6' Toilet Auger w/Bulb Head	5.6	2.5	6
60362	K-6P Cable	Replacement Cable	5.5	2.5	-



NEW



K-6P XL TOILET AUGER

- Optional drill attachment to power through toilet obstructions.
- Interchangeable heads to ensure the right tool for the job.
- Quick lock adjustment to extend the cable 6' and clear beyond the toilet.
- Carrying case to contain any mess.
- Zinc plated steel tubing to resist corrosion.
- Heavy-duty Tri-Wrap cable for optimum strength.

Catalog No.	Model No.	Description	Weight		STD. PACK
			lb	kg	
56663	K-6P XL	6' Toilet Auger w/Bulb Head	6.5	2.9	4

Accessory/Replacement Parts

Catalog No.	Model No.	Description	Weight	
			lb	kg
59623	K-6P XL Bulb Auger	Bulb Auger, 1 ¼" O.D.	0.5	0.22
59628	K-6P XL C-Cutter	C-Cutter, 1" O.D.	0.5	0.22
60362	K-6P XL Cable	Replacement Cable	5.5	2.5
61773	K-6P XL Drop Head	Drop Head Auger Accessory, 1 ½" O.D.	0.5	0.22



Grappler Hook

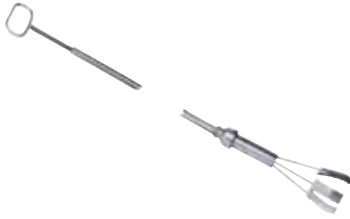

K-5 GRAPPLER HOOK

- Retrieves rocks, tools and other objects.
- Extends your reach 6' (2 m) for even the deepest traps.

Catalog No.	Model No.	Description	Weight	
			lb.	kg
59190	K-5	Grappler Hook	5	2.3
61820		Replacement Jaws	0	0.2

Sewer Tape



ONE-PIECE FLAT SEWER TAPE

- Sizes and lengths for use on sewer and drain lines through 8" (200 mm) in diameter and up to 100' (30,4 m) in length.
- Carrier included with all except 25' (7,6 m) model.
- All models have a hand grip and a spear point at one end and roller ball at the other.

Catalog No.	Model No.	Width		Thickness		Length		Capacity		Weight	
		in.	mm	in.	mm	ft.	m	in.	mm	lb.	kg
62530	E-2724	1/2	12	1/16	2	25	7.6	3/4 - 1 1/2	20 - 40	3	1.4
62535	E-2725					50	15.2			6	2.7
62540	E-2726					75	22.8			9	4.1
62545	E-2727					100	30.4			12	5.4
62555	E-2729	3/4	20	1/8	3	50	15.2	2 - 4	50 - 110	8	3.6
62565	E-2731					100	30.4			18	8.2
62595	E-2737					50	15.2	16	7.3		
62605	E-2739					100	30.4	34	15.4		
62615	E-2741	1	25	1/8	3	50	15.2	4 - 6	110 - 150	22	10.0
62625	E-2743					100	30.4			45	20.4

ACCESSORIES

Catalog No.	Model No.	Width		Thickness		Length		89750 Ball	89755 Ball	89760 Ball	89765 Ball	89770 Ball	89775 Ball
		in.	mm	in.	mm	ft.	m						
62530	E-2724	1/2	12	1/16	2	25	7.6						
62535	E-2725					50	15.2						
62540	E-2726					75	22.8						
62545	E-2727					100	30.4						
62555	E-2729	3/4	20	1/8	3	25	7.6						
62565	E-2731					50	15.2						
62560	E-2730					75	22.8						
62570	E-2732					100	30.4						
62575	E-2733	5/8	16	3/32	2.4	25	7.6						
62580	E-2734					50	15.2						
62585	E-2735					75	22.8						
62590	E-2736					100	30.4						
62595	E-2737	3/4	20	1/8	3	25	7.6						
62600	E-2738					50	15.2						
62605	E-2739					75	22.8						
62610	E-2740					100	30.4						
62615	E-2741	1	25	1/8	3	25	7.6						
62620	E-2742					50	15.2						
62625	E-2743					75	22.8						
62630	E-2744					100	30.4						
62635	E-2745	1 1/4	32	1/8	3	25	7.6						
62640	E-2746					50	15.2						
62645	E-2747					75	22.8						
62645	E-2747					100	30.4						

Hand Spinners



K-25 HAND SPINNER

- 3/4" to 1 1/2" (20 to 40 mm) Drain Lines
- The professional's choice for many years, the Model K-25 Hand Spinner offers premium quality. It's the ideal tool for the user who demands the best.
- Premium-quality, precision machined, 3-jaw chuck firmly secures cable. Releases cable with the flick-of-the-wrist.
- Cast aluminum ribbed hand grip won't slip in your hand.
- Rotary molded plastic drum won't dent or rust – cleans easily.
- Available in bulb head and drop head models. 5/16" (8 mm) x 25' (7.6 m) vinyl-wrapped inner core, kink-resistant cables.
- 5/16" x 25' (8 mm x 7.6 m) vinyl-wrapped inner core, kink-resistant cables.
- Balanced for comfortable operation.
- Drum Capacity: 5/16" x 25' (8 mm x 7.6 m).
- Works through traps and bends in sinks, tubs, drinking fountains, lavatories, urinals or vent pipes.

Standard Equipment

Catalog No. Model No.	Description	58890 K-25-BP	58895 K-25-DH
56782	5/16" (8 mm) x 25' (7.6 m) Inner Core with Bulb Auger	I	
56787	5/16" (8 mm) x 25' (7.6 m) Inner Core with Drop Head Auger		I

Catalog No.	Model No.	Description	Cable Diameter		Length		Weight	
			in.	mm	ft.	m	lb.	kg
58890	K-25-BP	Hand Spinner with C-1IC Bulb Auger Cable	5/16	8	25	7.6	8	3.6
58895	K-25-DH	Hand Spinner with C-2IC Drop Head Cable	5/16	8	25	7.6		



K-26 HAND SPINNER

- 3/4" to 1 1/2" (19 to 40 mm) Drain Lines
- Ideal for users seeking excellent performance and value.
- Slip-resistant collet chuck that grips cable with the flick-of-the-wrist.
- 5/16" x 25' (8 mm x 7.6 m) hollow core cable with bulb head auger.
- Rotary molded plastic drum that won't rust or dent – cleans easily.
- Open drum design that permits access to cable and allows application of RIDGID® Cable Rust Inhibitor.

Standard Equipment

Catalog No. Model No.	Description	59812 K-26
62225	5/16" (8 mm) x 25' (7.6 m) with Bulb Auger	I

Catalog No.	Model No.	Description	Cable Diameter		Length		Weight	
			in.	mm	ft.	m	lb.	kg
59812	K-26	Hand Spinner with C1 Bulb Head Cable	5/16	8	25	7.6	6	2.7

Hand Spinners

NEW



KWIK-SPIN+™ HAND SPINNER WITH AUTOFEED®

- 1/2" to 1 1/2" (12.6 to 40 mm) Drain Lines.
- Cable is positively retained in the drum to prevent cable pullout.
- AUTOFEED® Trigger Technology allows cable to self-feed down the drain.
- Lightweight polyethylene drum will not dent or rust.
- Pull the trigger and turn the drum for a clean drain without the mess.

Catalog No.	Model No.	Description	Diameter		Length		Weight	
			in.	mm	ft.	m	lb.	kg
57038	Kwik-Spin+	Hand Spinner with Autofeed®	1/4	6.3	25	7.6	3.6	1.6

NEW



POWER SPIN+™ WITH AUTOFEED®

- 1/2" to 1 1/2" (12.7 to 38.1 mm) Drain Lines.
- Cable is positively retained in the drum to prevent cable pullout.
- Kink-resistant MAXCORE® cable is designed for drill powered operation up to 500 RPMs.
- AUTOFEED® Trigger Technology allows cable to self-feed down the drain.
- Pull the trigger and turn the drum for a clean drain without the mess.

Catalog No.	Model No.	Description	Diameter		Length		Weight	
			in.	mm	ft.	m	lb.	kg
57043	Power Spin+	Power Spinner Drain Cleaner	1/4	6	25	8	5	2.2
42163	Cable	MAXCORE Replacement Cable	1/4	6	25	8	3	1.4



Sink Machines

NEW



POWERCLEAR™ MACHINE

- 3/4" to 1 1/2" (20 mm to 12.6 mm) Drain Lines
- AUTOFEED® Technology – Keeps your hands clean and free from touching the cable while advancing and retrieving.
- Heavy Duty Inner Core Cable – For long life, increased strength and kink resistance.
- Clear Cover – Allows user to view how much cable is remaining.
- Two-Piece Guide Hose – Use one piece for close applications and extension for areas where access is limited.
- Easy Pull Drain Plug – Drain access water after each use to extend cable life.
- Guide Hose – Helps keep work area clean.

Catalog No.	Model No.	Description	Cable Diameter		Cable Length		Voltage	Weight	
			in.	mm	ft.	m	V	lb.	kg
55808	PowerClear	Drain Cleaning Machine	-	-	-	-	120	12	5.4
55983		1/4" - 30' Replacement Cable	1/4	6	30	9	-	5.3	2.4



K-40 SINK MACHINE

- 3/4" to 2 1/2" (20 mm to 75 mm) Drain Lines
- The Model K-40 Sink Machine is ideal for cleaning small secondary drain lines.
- 1/4" (6 mm) cables best for 3/4" to 1 1/2" (20 mm to 40 mm) lines.
- 5/16" (8 mm) cables best for 3/4" to 1 1/2" (20 mm to 40 mm) lines.
- 3/8" (10 mm) cables best for 1 1/4" to 2 1/2" (40 mm to 75 mm) lines.
- The K-40 sits flat on the floor or countertop and also tips onto its back for easy access to sink drains and bathtubs full of water. It practically eliminates job site cleanup thanks to the patented guide hose two-way AUTOFEED® control. It completely contains the rotating cable and eliminates any waste water splashing or spraying.
- 1/8 HP induction motor quietly delivers enough torque to clear even the toughest blockages.
- Premium-quality, compression-wound inner core cable combines strength and flexibility to resist kinking.
- Two-piece "twist lock" drum housing will not dent or corrode and allows easy access to the inner drum and cable.
- Special inner drum design reduces cable flip-over inside the drum and drum leakage.
- Two-way AUTOFEED control advances and retrieves the drain cleaning cable with a simple push of a lever keeping you and the work area clean.
- Includes RIDGID® drain cleaning gloves and operator's manual.



Catalog No.	Model No.	Description	Voltage	Weight	
			V	lb.	kg
71702	K-40	Machine with: C-131C, 5/16" x 35' (8 mm x 10.7 m) Cable with Inner Drum	115	29	13.0
71722	K-40.AF	Machine with: AUTOFEED, Guide Hose, Mounting Bracket, C-131C SB, 5/16" x 35' (8 mm x 10.7 m) Speed Bump Cable with Inner Drum	115	33	15.0
71732		230			
78347	K-40B AF	Battery Powered Machine with: AUTOFEED, Guide Hose, Mounting Bracket, C-131C SB, 5/16" x 35' (8 mm x 10.7 m) Cable with Inner Drum, (2) 14.4V Battery Packs, 14.4V Battery Charger	14.4	24	11.0
71717	K-40 AF 110 V	Machine with: AUTOFEED, Guide Hose, Mounting Bracket, C-131C SB, 5/16" x 35' (8 mm x 10.7 m) Speed Bump Cable with Inner Drum	110	-	-

Standard Equipment

Catalog No. Model No.	Description	71702 K-40	71722 K-40AF	71727 K-40AF	71732 K-40B AF	78347 K-40AF 110V
56792	5/16" (8 mm) x 35' (10.7 m) Inner Core with Bulb Auger					
95847	5/16" (8 mm) x 35' (10.7m) Inner Core Speed Bump with Bulb Auger					



Cables

	Catalog No.	Model No.	Description	Weight	
				lb.	kg
	50647	S-1	1/4" (6 mm) x 15' (4,6 m) with Funnel Auger	2 1/4	1.0
	50652	S-2	1/4" (6 mm) x 25' (7,6 m) with Funnel Auger	3 1/2	
	50657	S-3	1/4" (6 mm) x 35' (10,7 m) with Funnel Auger	5	
	62225	C-1	5/16" (8 mm) x 25' (7,6 m) with Bulb Auger	3 1/2	2.0
	56782	C-11C	5/16" (8 mm) x 25' (7,6 m) Inner Core with Bulb Auger	4	
	89400	C-21	5/16" (8 mm) x 50' (15,2 m) with Bulb Auger	7	3.0
	56792	C-131C	5/16" x 35' (8 mm x 10,7 m) Inner Core with Bulb Auger	5 1/2	
	95847	C-131CSB	5/16" x 35' (8 mm x 10,7 m) Inner Core Speed Bump with Bulb Auger	5 1/2	2.0
	62235	C-2	5/16" (8 mm) x 25' (7,6 m) with Drop Head Auger	3 1/2	
	56787	C-21C	5/16" (8 mm) x 25' (7,6 m) Inner Core with Drop Head Auger	4	3.0
	89405	C-22	5/16" (8 mm) x 50' (15,2 m) with Drop Head Auger	7	
	56797	C-231C	5/16" (8 mm) x 35' (10,7 m) Inner Core with Drop Head Auger	5 1/2	2.0
	62245	C-4	3/8" (10mm) x 25' (7,6 m) with Male Coupling	4 1/2	
	62250	C-5	3/8" (10mm) x 35' (10,7 m) with Bulb Auger	8 1/4	4.0
	62260	C-6	3/8" (10 mm) x 35' (10,7 m) with Male Coupling	8 1/2	
	96037	C-61C	3/8" (10mm) x 35' (10,7 m) Inner Core with Male Coupling	8 1/2	

Tools

	Catalog No.	Model No.	Description	Replac. Blade(s)
	62990	T-201	Straight Auger, 5" (125 mm) Long	
	62995	T-202	Bulb Auger, 1 1/8" (29 mm) O.D.	-
	63000	T-203	Bulb Auger 7/8" (22 mm) O.D.	
	54837	T-204	"C" Cutter 1" (25 mm)	54832
	63005	T-205	"C" Cutter, 1 3/8" (35 mm)	97835
	63010	T-206	Funnel Auger, 3" (80 mm) Long	-
	63030	T-210	Spade Cutter, 1" (25 mm)	97905
	63035	T-211	Spade Cutter, 1 3/8" (35 mm)	97825
	63040	T-212	Spade Cutter, 1 3/4" (45 mm)	92850
	63045	T-213	4-Blade Cutter, 1" (25 mm)	97795
	63050	T-214	4-Blade Cutter, 1 3/8" (35 mm)	97910
	63055	T-215	4-Blade Cutter, 1 3/4" (45 mm)	97915
	63065	T-217	Drop Head Auger, 4" (110 mm) Long	
	55457	T-225	Retrieving Auger	-
	48482	T-250	Tool Set includes: T-203, T-205, T-210, T-217, A-13	-
	52812	T-230	H-D "C" Cutter, 2" (50 mm)	92815
	52817	T-231	H-D "C" Cutter, 2 1/2" (65 mm)	92820
	52822	T-232	H-D "C" Cutter, 3" (80 mm)	92835
	59230	A-13	3/8" Cable Pin Key	-

Accessories

	Catalog No.	Model No.	Description
	26558	A-40AF	AUTOFEED Assembly & Guide Hose for K-40 Includes Mounting Bracket
	23913	A-39AF	Replacement AUTOFEED Cartridge
	71757	A-40G	A-40G Guide Hose Assembly
	72702	A-40B	Mounting Bracket
	83407		14.4V Battery Pack
	83417		115V Charger
	71847		Cable Torque Arm
	68917		Drum Liner
	76597		Top Roller Bearing Housing Assy.
	76817		C-6 Cable Kit incl. Inner Drum, C-6 Cable Torque Arm, T-250 Tool Set
	98072		C-61C Cable Kit including: Inner Drum, C-61C Cable, Torque Arm, T-250 Tool Set
	41937		RIDGID® Leather Drain Cleaning Gloves
	70032		RIDGID® PVC Drain Cleaning Gloves

Sink Machines



K-45 SINK MACHINE

- 3/4" to 2 1/2" (20 mm to 75 mm) Drain Lines
- 1/4" (6 mm) cables best for 3/4" to 1 1/2" (20 mm to 40 mm) lines.
- 5/16" (8 mm) cables best for 3/4" to 1 1/2" (20 mm to 40 mm) lines.
- 3/8" (10 mm) cables best for 1 1/4" to 2 1/2" (30 mm to 75 mm) lines.
- Excellent for small line cleaning. Opens clogged lavatory, sink lines, urinals and tub or shower drains.
- Advanced two-way AUTOFEED® control keeps hands and work area clean – advances & retrieves cable with push of a lever.
- Manual version has a slide-action chuck for quick locking/releasing of cable (Not available in Europe).
- Lightweight, easy-to-use, no setup required.
- Variable speed power unit rotates cable 0-600 RPMs.
- Two-piece twist lock canister with interchangeable inner drum – Makes cable change-out simple; easy to match the right cable for the job.
- Inner drum prevents water leaks and greatly reduces cable flip-over inside the drum.
- Drums won't rust or dent-ever.
- Drum Capacity: 50' of 5/16" (15 m of 8 mm) or 35' of 3/8" (11 m of 10 mm).
- Includes RIDGID® drain cleaning gloves and operator's manual.

INNER CORE CABLES

(MODELS C-11C, C-61C, C-131C, C-21C, C-231C)

- Vinyl-wrapped inner core to prevent core from rusting to spring – enhances cable life.
- Compression wound for strength.
- Resists kinking and negotiates tough bends and traps.
- Provides good flexibility and cleaning power to the cable end.

	Catalog No.	Model No.	Description	Voltage		Weight	
				V	lb.	kg	
K-45AF	35473	K-45AF	Machine with Gloves: - C-11C, 5/16" x 25' (8 mm x 7.6 m) Inner Core Cable with Inner Drum	115	11	5.0	
	36033		Machine with Gloves: - C-11C, 5/16" x 25' (8 mm x 7.6 m) Inner Core Cable with Inner Drum	230	13.8	6.5	
	35998	K-45AF-1	Same as Model No. K-45AF plus Gloves: C-6429 Carrying Case	115	27	12.2	
	36038			230			
	36003	K-45AF-5	Machine with Gloves: - C-11C, 5/16" x 25' (8 mm x 7.6 m) Inner Core Cable with Inner Drum - C-6, 3/8" x 35' (10 mm x 10.7 m) Cable with Inner Drum - T-250, Five -Piece Tool Set for 3/8" (10 mm) Cable - C-6429 Carrying Case	115	34	15.4	
	36043		Machine with Gloves: - C-11C, 5/16" x 25' (8 mm x 7.6 m) Inner Core Cable with Inner Drum - C-6, 3/8" (10 mm) x 25' (10.7 m) Cable with Inner Drum - T-250, Five-Piece Tool Set for 3/8" (10 mm) Cable - C-6429 Carrying Case	230			
	36008	K-45AF-7	Machine with Gloves: - C-11C, 5/16" x 25' (8 mm x 7.6 m) Inner Core Cable w/Inner Drum - C-6, 3/8" x 35' (10 mm x 10.7 m) Cable with Inner Drum - C-21, 5/16" x 50' (8 mm x 15.2 m) Cable with Inner Drum - T-250, Five -Piece Tool Set for 3/8" (10 mm) Cable - C-6429 Carrying Case	115	42	19.0	
K-45	36018	K-45	Machine with Gloves: - C-11C, 5/16" x 25' (8 mm x 7.6 m) Inner Core Cable with Inner Drum	115	11	5.0	
	36048			230			
	36013	K-45-1	Same as Model No. K-45 plus Gloves: C-6429 Carrying Case	115	27	12.2	
	36053			230			
	36023	K-45-5	Machine with Gloves: - C-11C, 5/16" x 25' (8 mm x 7.6 m) Inner Core Cable with Inner Drum - C-6, 3/8" x 35' (10 mm x 10.7 m) Cable with Inner Drum - T-250, Five -Piece Tool Set for 3/8" (10 mm) Cable - C-6429 Carrying Case	115	34	15.4	
	36058	K-45	Machine with Gloves: - C-11C, 5/16" x 25' (8 mm x 7.6 m) Inner Core Cable with Inner Drum - C-6, 3/8" x 35' (10 mm x 10.7 m) Cable with Inner Drum - T-250, Five -Piece Tool Set for 3/8" (10 mm) Cable - C-6429 Carrying Case	230			
	36028	K-45-7	Machine with Gloves: - C-11C, 5/16" x 25' (8 mm x 7.6 m) Inner Core Cable with Inner Drum - C-6, 3/8" x 35' (10 mm x 10.7 m) Cable Inner Drum - C-21, 5/16" x 50' (8 mm x 15.2 m) Cable with Inner Drum - T-250, Five -Piece Tool Set for 3/8" (10 mm) Cable - C-6429 Carrying Case	115	42	19.0	

Standard Equipment

Catalog No. Model No.	Description	35473 K-45AF	36033 K-45AF	35998 K-45AF-1	36038 K-45AF-1	36003 K-45AF-5	36043 K-45AF-5	36008 K-45AF-7	36018 K-45	36048 K-45	36013 K-45-1	36053 -	36023 K-45-5	36058 K-45	36028 K-45AF-7
56782	5/16" (8 mm) x 25' (7.6 m) Inner Core with Bulb Auger														
89410	Carrying Case														
48482	Tool Set includes: T-203, T-205, T-210, T-217, A-13														
62260	3/8" (10 mm) x 35' (10.7 m) with Male Coupling														
89400	5/16" (8 mm) x 50' (15.2 m) with Bulb Auger														



Cables

	Catalog No.	Model No.	Description	Weight	
				lb.	kg
1/4"-6 mm	50647	S-1	1/4" (6 mm) x 15' (4,6 m) with Funnel Auger	2 1/4	1.0
	50652	S-2	1/4" (6 mm) x 25' (7,6 m) with Funnel Auger	3 1/2	1.6
	50657	S-3	1/4" (6 mm) x 35' (10,7 m) with Funnel Auger	5	2.2
5/16"-8 mm	62225	C-1	5/16" (8 mm) x 25' (7.6 m) with Bulb Auger	3 1/2	1.6
	56782	C-11C	5/16" (8 mm) x 25' (7.6 m) Inner Core with Bulb Auger	4	1.8
	89400	C-21	5/16" (8 mm) x 50' (15,2 m) with Bulb Auger	7	3.2
	56792	C-131C	5/16" x 35' (8 mm x 10.7 m) Inner Core with Bulb Auger	5 1/2	2.5
	62235	C-2	5/16" (8 mm) x 25' (7,6 m) with Drop Head Auger	3 1/2	1.6
	56787	C-21C	5/16" (8 mm) x 25' (7.6 m) Inner Core with Drop Head Auger	4	1.8
	89405	C-22	5/16" (8 mm) x 50' (15,2 m) with Drop Head Auger	7	3.2
	56797	C-231C	5/16" (8 mm) x 35' (10,7 m) Inner Core with Drop Head Auger	5 1/2	2.5
3/8"-10 mm	62245	C-4	3/8" (10mm) x 25' (7,6 m) with Male Coupling	4 1/2	2.0
	62250	C-5	3/8" (10mm) x 35' (10,7 m) with Bulb Auger	8 1/4	3.8
	62260	C-6	3/8" (10 mm) x 35' (10,7 m) with Male Coupling	8 1/2	4.0
	96037	C-61C	3/8" (10mm) x 35' (10,7 m) Inner Core with Male Coupling	8 1/2	4.0

Tools – Fits C-4, C-6 and C-61C Cables

	Catalog No.	Model No.	Description	Replac. Blade(s)
	62990	T-201	Straight Auger, 5" (125 mm) Long	-
	62995	T-202	Bulb Auger, 1 1/8" (29 mm) O.D.	-
	63000	T-203	Bulb Auger 7/8" (22 mm) O.D.	-
	54837	T-204	"C" Cutter 1" (25 mm)	54832
	63005	T-205	"C" Cutter, 1 3/8" (35 mm)	97835
	63010	T-206	Funnel Auger, 3" (80 mm) Long	-
	63030	T-210	Spade Cutter, 1" (25 mm)	97905
	63035	T-211	Spade Cutter, 1 3/8" (35 mm)	97825
	63040	T-212	Spade Cutter, 1 3/4" (45 mm)	92850
	63045	T-213	4-Blade Cutter, 1" (25 mm)	97795
	63050	T-214	4-Blade Cutter, 1 3/8" (35 mm)	97910
	63055	T-215	4-Blade Cutter, 1 3/4" (45 mm)	97915
	63065	T-217	Drop Head Auger, 4" (110 mm) Long	-
	55457	T-225	Retrieving Auger	-
	52812	T-230	H-D "C" Cutter, 2" (50 mm)	92815
	52817	T-231	H-D "C" Cutter, 2 1/2" (65 mm)	92820
	52822	T-232	H-D "C" Cutter, 3" (80 mm)	92835
	48482	T-250	Tool Set includes: T-203, T-205, T-210, T-217, A-13	-
	59230	A-13	3/8" Cable Pin Key	-

Accessories

Catalog No.	Model No.	Description
68917	-	Drum Liner
89410	C-6429	Carrying Case
76817	-	C-6 Cable Kit incl. Inner Drum, C-6 Cable Torque Arm, T-250 Tool Set
98072	-	C-61C Cable Kit including: Inner Drum, C-61C Cable, Torque Arm, T-250 Tool Set
23908	-	Drum Front and AUTOFEED Assembly
23913	A-39AF	Replacement AUTOFEED Cartridge
41937	-	RIDGID® Leather Drain Cleaning Gloves
70032	-	RIDGID® PVC Drain Cleaning Gloves

Drum Machines



K-400 DRUM MACHINE

- 1 1/2" to 4" (30 mm to 110 mm) Drain Lines
- The Model K-400 offers several unique, user-friendly features to make the toughest drain cleaning jobs easier and hassle-free. Designed with a sleek profile, the Model K-400 is a great fit for drain cleaners, service plumbers, facility and institutional maintenance departments and property management companies.
- 3/8" (10 mm) cable best for 1 1/2" to 3" (40 mm to 75 mm) lines.
- 1/2" (12 mm) cable best for 3" to 4" (50 mm to 110 mm) lines.
- **Integrated Transport Cart** – easy movement to and from the job site. Heavy-duty, large wheels easily navigate over bumps and up stairs.
- **Retractable Handle** – high-handle height during transport.
- **Cable Control System** – causes the drum to stop spinning when the blade becomes lodged in a blockage, limits potential for cable to flip-over in the drum and helps indicate to operator when blockages are encountered.
- **"Solid Core" Cable** – uses tough 3/8" (10 mm) or 1/2" (12 mm) Integral Wound (IW) solid core cable that is rugged and kink resistant.
- **AUTOFEED® Control** – offered as an accessory, this patented, automatic cable feed powers cable in and out of the drain. Reverse the direction of the AUTOFEED and the cable feeds back into the drum.

SPECIFICATIONS

- **Drum Capacity** – 100' (30,5 m) of 3/8" (10 mm) diameter cable or 75' (22,5 m) of 1/2" (12 mm) diameter cable
- **Motor** – 1/3 HP, motor spins cable at 165 RPM
- **Weight (Machine Only)** – 45 lbs. (20.4 kg)
- **Dimensions** – Length 21" (53 cm) 24" (61 cm) with AUTOFEED, Height 23" (58,5 cm) Width 17" (43.2 cm)
- All Model K-400 machines are supplied with RIDGID® drain cleaning gloves and operator's manual

Catalog No.	Model No.	Description	Voltage		Weight	
			V	lb.	kg	
52363	K-400 with C-32 IW	Machine with Gloves & Std. Equipment: C-32 IW 3/8" x 75' (10 mm x 23 m) Solid Core (Integral Wound) Cable, T-260 Tool Set	115	68	31.0	
26993	K-400 with C-31 IW	Machine with Gloves & Std. Equipment: C-31 IW 3/8" x 50' (10 mm x 15.2 m) Solid Core (Integral Wound) Cable, T-260 Tool Set Includes: T-202 Bulb Auger, T-205 "C" Cutter, T-211 Spade Cutter, A-13 Coupling Pin	115	60	27.2	
26998	K-400 with C-45 IW	Machine with Gloves & Std. Equipment: C-45 IW 1/2" x 75' (12 mm x 23 m) Solid Core (Integral Wound) Cable, T-260 Tool Set	115	81	37.0	
27003	K-400 with C-44 IW	Machine with Gloves & Std. Equipment: C-44 IW 1/2" x 50' (12 mm x 15.2 m) Solid Core (Integral Wound) Cable, T-260 Tool Kit	115	68	31.0	
27008	K-400 AF with C-32 IW	Machine with Gloves & Std. Equipment: AUTOFEED, C-32 IW 3/8" x 75' (10 mm x 23 m) Solid Core (Integral Wound) Cable, T-260 Tool Set	115	79	36.0	
27013	K-400 AF with C-45 IW	Machine with Gloves & Std. Equipment: AUTOFEED, C-45 IW 1/2" x 75' (12 mm x 23 m) Solid Core (Integral Wound) Cable, T-260 Tool Set	115	93	42.0	
27033	K-400 with C-45 IW	Machine with RIDGID Drain Cleaning Gloves – C-45 IW 1/2" x 75' (12 mm x 23 m) Solid Core (Integral Wound) Cable – T-260 Tool Set	230	81	37.0	
28103	K-400 AF with C-45 IW	Machine with RIDGID Drain Cleaning Gloves – AUTOFEED – C-45 IW 1/2" x 75' (12 mm x 23 m) Solid Core (Integral Wound) Cable – T-260 Tool Set	230	93	42.0	
28098	K-400 AF with C-32 IW	Machine with RIDGID Drain Cleaning Gloves – AUTOFEED – C-32 IW 3/8" x 75' (10 mm x 23 m) Solid Core (Integral Wound) Cable – T-260 Tool Set	230	79	36.0	

Standard Equipment

Catalog No. Model No.	Description	24853	26993	26998	27003	27008	27013
		K-400 w/C-32 IW	K-400 w/C-31 IW	K-400 w/C-45 IW	K-400 w/C-44 IW	K-400 AF w/C-32 IW	K-400 AF w/C-45 IW
49002	Tool Set [3/8" (10 mm) - K-400] Includes: – T-202 Bulb Auger – T-205 "C" Cutter – T-211 Spade Cutter – A-13 Pin Key						
87582	3/8" (10 mm) x 75' (23 m) IWCable						
87577	3/8" (10 mm) x 50' (15 m) IW Cable						
87597	1/2" (12 mm) x 75' (23m) IW Cable						
87592	1/2" (12 mm) x 50' (15 m) IW Cable						
26773	K-400 AutoFeed Assembly						

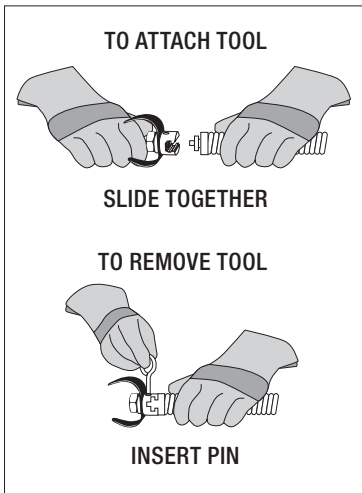

Cables

	Catalog No.	Model No.	Description	Weight	
				lb.	kg
3/8" - 10 mm	87577	C-31IW	3/8" (10 mm) x 50' (15 m) IW Cable	18	8.2
	87582	C-32IW	3/8" (10 mm) x 75' (23 m) IWCable	26	11.8
	87587	C-33IW	3/8" (10 mm) x 100' (30 m) IW Cable	34	15.4
	91037		Repair End for 3/8" (10 mm) IW Cable	0.5	0.2
1/2" - 12 mm	87592	C-44IW	1/2" (12 mm) x 50' (15 m) IW Cable	18	8.2
	87597	C-45IW	1/2" (12 mm) x 75' (23m) IW Cable	26	11.8
	91042		Repair End for 1/2" (12 mm) IW Cable	0.6	0.3

Tools

	Catalog No.	Model No.	Description	Replac. Blade(s)
	62990	T-201	Straight Auger, 5" (125 mm) Long	-
	62995	T-202	Bulb Auger, 1 1/8" (29 mm) O.D.	-
	63000	T-203	Bulb Auger 7/8" (22 mm) O.D.	-
	63005	T-205	"C" Cutter, 1 3/8" (35 mm)	97835
	63010	T-206	Funnel Auger, 3" (80 mm) Long	-
	63015	T-207	Spiral Cutter, 1 1/4" (32 mm)	97840
	63020	T-208	Spiral Cutter, 1 1/2" (40 mm)	97895
	63025	T-209	Spiral Cutter, 2" (50 mm)	97900
	63030	T-210	Spade Cutter, 1" (25 mm)	97905
	63035	T-211	Spade Cutter, 1 3/8" (35 mm)	97825
	63040	T-212	Spade Cutter, 1 3/4" (45 mm)	92850
	63045	T-213	4-Blade Cutter, 1" (25 mm)	97795
	63050	T-214	4-Blade Cutter, 1 3/8" (35 mm)	97910
	63055	T-215	4-Blade Cutter, 1 3/4" (45 mm)	97915
	63060	T-216	Chain Knocker, 2" (50 mm)	98000
	63065	T-217	Drop Head Auger, 4" (110 mm) Long	-
	49002	T-260	Tool Set 3/8" (10 mm) - K-400] Includes: - T-202 Bulb Auger - T-205 "C" Cutter - T-211 Spade Cutter - A-13 Pin Key	-

Accessories

	Catalog No.	Model No.	Description	Weight	
				lb.	kg
	41937	-	RIDGID® Leather Drain Cleaning Gloves		
	70032	-	RIDGID® PVC Drain Cleaning Gloves	1/2	0.2
	59230	A-13	3/8" Cable Pin Key		
	26773	-	K-400 AutoFeed Assembly	2	0.9
	27048	-	Drum Assembly	10	4.5
	92607	-	3/8" x 1/2" Tool Adaptor for use w/T-100 tools		
	92682	-	3/8" x 1/2" Drop Head Adaptor	1/2	0.2
	92687	-	Drop Head Tool Adaptor 1/2" (12 mm)		
	26778	-	Guide Hose Assembly	2	0.9
	51317	C-9	5/8" (16 mm) x 10' (3,1 m) Heavy-Duty Wind	5	2.2

Drum Machines

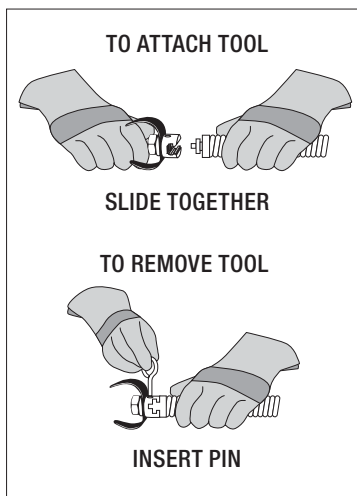

For C-4, C-6, C-6/C, C-7, C-8, C-9, C-10, C-11, C-12, C-14, C-15, C-31, C-32, C-33, C-44, C-45, and C-46 & all IW Cables.

K-3800 DRUM MACHINE

- 3/4" (20 mm) to 4" (110 mm) Drain Lines
- A powerful, easy to transport, versatile machine for cleaning indoor drains. Requires minimal set-up to clean sink lines, floor drains and roof vents.
- Rugged, corrosion-resistant molded cable drum won't dent or rust. The drum tilt adjusts for proper cable feed angle. Inner-drum guards against cable flip-over inside the drum.
- Cable drum quick-release and built-in hand-holds allow easy cable change and transport.
- Maximum drum capacity is 100' (30,5 m) of 3/8" (10 mm) or 90' (27 m) of 1/2" (12 mm) continuous length cable
- 3/8" (10 mm) cable best for 1 1/2" (40 mm) to 3" (75 mm) lines up to 100' (30,5 m)
- 1/2" (12 mm) cable best for 2" (50 mm) to 4" (110 mm) lines up to 90' (27 m)
- Optional sink drum holds up to 50' (15 m) of 5/16" (8 mm) or 1/4" (6 mm) cable
- Ideal for cleaning through 3/4" (20 mm) to 1 1/2" (40 mm) sink traps
- Powerful 1/10 HP universal motor spins cable at 240 RPM. When cable hits blockage, motor gears down automatically to deliver more power and enhance operator control.
- Tools connect to cable in seconds.
- Optional heavy duty AUTOFEED® system.
- Includes RIDGID® leather drain cleaning gloves and operator's manual.

Machine Options

Catalog No.	Model No.	Description	Voltage		Weight	
			V	lb.	kg	
53107	K-3800	Machine with Gloves	115	42	19.0	
53112	K-3800 with C-31	Machine with Std. Equip: C-31, 3/8" x 50' (10 mm x 15.2 m) Cable, T-202 Bulb Auger, T-205 "C" Cutter, T-211 Spade Cutter, A-13 Pin Key, Pair of Gloves	115	65	29.2	
53117	K-3800 with C-32	Machine with Std. Equip: C-32, 3/8" x 75' (10 mm x 22.8.2 m) Cable, T-202 Bulb Auger, T-205 "C" Cutter, T-211 Spade Cutter, A-13 Pin Key, Pair of Gloves	115	71	32.2	
53122	K-3800 with C-45	Machine with Std. Equip: C-45, 1/2" x 75' (12 mm x 22.8 m) Cable, T-102 Funnel Auger, T-142 Knife Blade Cutter, T-107 Spade Cutter, A-12 Pin Key, Pair of Gloves	115	83	37.7	
53127	K-3800 with C-46	Machine with Std. Equip: C-46, 1/2" x 90' (12 mm x 27.4 m) Cable, T-102 Funnel Auger, T-142 Knife Blade Cutter, T-107 Spade Cutter, A-12 Pin Key, Pair of Gloves	115	91	41.3	
59462	K-3800	Machine with Gloves	230	42	19.0	
63822	K-3800 with C-45	Machine with Std. Equip: C-45, 1/2" x 75' (12 mm x 22.8 m) Cable, T-102 Funnel Auger, T-142 Knife Blade Cutter, T-107 Spade Cutter, A-12 Pin Key, Pair of Gloves	230	83	37.7	
63827	K-3800 with C-32	Machine with Std. Equip: C-32, 3/8" x 75' (10 mm x 22.8 m) Cable, T-202 Bulb Auger, T-205 "C" Cutter, T-211 Spade Cutter, A-13 Pin Key, Pair of Gloves	230	71	32.2	

Standard Equipment

Catalog No. Model No.	Description	53107 K-3800	53112 K-3800 w/C-31	53117 K-3800 w/C-32	53122 K-3800 w/C-45	53127 K-3800 w/C-46	59462 K-3800	63822 K-3800 w/C-45	63827 K-3800 w/C-32
41937	RIDGID Leather Drain Cleaning Gloves								
37842	3/8" (10 mm) x 50' (15m) IC Cable								
49002	Tool Set [3/8" (10 mm) - K-400] Includes: - T-202 Bulb Auger - T-205 "C" Cutter - T-211 Spade Cutter - A-13 Pin Key								
37862	1/2" (12 mm) x 75' (23 m) IC Cable								
54992	Tool Set: - T-102 Funnel Auger - T-142 Knife Blade Cutter - T-107 Spade Cutter - A-12 Pin Key								
55467	1/2" (12 mm) x 90' (28m) IC Cable								
37847	3/8" (10 mm) x 75' (23 m) IC Cable								

Inner Core (IC) Cables

	Catalog No.	Model No.	Description	Weight	
				lb.	kg
3/8" - 10 mm	37842	C-31	3/8" (10 mm) x 50' (15m) IC Cable	18	8.2
	37847	C-32	3/8" (10 mm) x 75' (23 m) IC Cable	26	11.8
	37852	C-33	3/8" (10 mm) x 100' (30m) IC Cable	34	15.4
	51752	T-122	Repair End, 3/8" (10 mm)	1	0.5
1/2" - 12 mm	37857	C-44	1/2" (12 mm) x 50' (15m) IC Cable	27	12.2
	37862	C-45	1/2" (12 mm) x 75' (23m) IC Cable	39	17.7
	37867	C-45HC	1/2" (12 mm) x 75' (23m) Hollow Core Cable	38	17.2
	55467	C-46	1/2" (12 mm) x 90' (28m) IC Cable	47	21.2
	59917	T-121	Repair End, 1/2" (12 mm)	3/4	0.8

Integrated Wound (IW) Cables

	Catalog No.	Model No.	Description	Weight	
				lb.	kg
3/8" - 10 mm	87577	C-31IW	3/8" (10 mm) x 50' (15 m) IW Cable	18	8.2
	87582	C-32IW	3/8" (10 mm) x 75' (23 m) IW Cable	26	11.8
	87587	C-33IW	3/8" (10 mm) x 100' (30 m) IW Cable	34	15.4
	91037		Repair End for 3/8" (10 mm) IW Cable	1/2	0.2
1/2" - 12 mm	87592	C-44IW	1/2" (12 mm) x 50' (15 m) IW Cable	18	8.2
	87597	C-45IW	1/2" (12 mm) x 75' (23m) IW Cable	26	11.8
	91042		Repair End for 1/2" (12 mm) IW Cable	3/5	0.3

Sink Drum Cables

	Catalog No.	Model No.	Description	Weight	
				lb.	kg
1/4" - 6 mm	50652	S-2	1/4" (6 mm) x 25' (7,6 m) with Funnel Auger	3 1/2	1.6
	50657	S-3	1/4" (6 mm) x 35' (10,7 m) with Funnel Auger	5	2.2
5/16" - 8 mm	56782	C-11C	5/16" (8 mm) x 25' (7.6 m) Inner Core with Bulb Auger	4	1.8
	56792	C-131C	5/16" x 35' (8 mm x 10.7 m) Inner Core with Bulb Auger	5 1/2	2.5
	56787	C-21C	5/16" (8 mm) x 25' (7.6 m) Inner Core with Drop Head Auger	4	1.8
	56797	C-231C	5/16" (8 mm) x 35' (10,7 m) Inner Core with Drop Head Auger	5 1/2	2.5

Accessories

	Catalog No.	Model No.	Description	Weight	
				lb.	kg
	55002	A-380	Standard Drum Assembly	12 1/2	5.6
	55007	A-381	Sink Drum Assembly		
	55012	A-381-A	Sink Drum with 25' (7,6 m) x 5/16" (8 mm) IC Cable w/Bulb Head	16 1/2	7.5
	41937		RIDGID® Leather Drain Cleaning Gloves	1/2	0.2
	70032		RIDGID® PVC Drain Cleaning Gloves		
	59230	A-13	3/8" Cable Pin Key	18	8.2
	59225	A-12	1/2" Cable Pin Key		
	55017		Transport Cart	18	8.2
	60087	A3800 PF	AUTOFEED® Assembly	7 3/8	3.3
	62412		Guide Hose Adapter for Sink Drum	3 1/2	1.6

Tools Fit 3/8" (10 mm) IC, 3/8" (10 mm) IW and 1/2" (12 mm) IW Cables

	Catalog No.	Model No.	Description	Replac. Blade(s)
	62990	T-201	Straight Auger, 5" (125 mm) Long	-
	62995	T-202	Bulb Auger, 1 1/8" (29 mm) O.D.	-
	63000	T-203	Bulb Auger 7/8" (22 mm) O.D.	-
	54837	T-204	"C" Cutter 1" (25 mm)	54832
	63005	T-205	"C" Cutter, 1 3/8" (35 mm)	97835
	52812	T-230	H-D "C" Cutter, 2" (50 mm)	92815
	52817	T-231	H-D "C" Cutter, 2 1/2" (65 mm)	92820
	52822	T-232	H-D "C" Cutter, 3" (80 mm)	92835
	63010	T-206	Funnel Auger, 3" (80 mm) Long	-
	63015	T-207	Spiral Cutter, 1 1/4" (32 mm)	97840
	63020	T-208	Spiral Cutter, 1 1/2" (40 mm)	97895
	63025	T-209	Spiral Cutter, 2" (50 mm)	97900
	63030	T-210	Spade Cutter, 1" (25 mm)	97905
	63035	T-211	Spade Cutter, 1 3/8" (35 mm)	97825
	63040	T-212	Spade Cutter, 1 3/4" (45 mm)	92850
	63045	T-213	4-Blade Cutter, 1" (25 mm)	97795
	63050	T-214	4-Blade Cutter, 1 3/8" (35 mm)	97910
	63055	T-215	4-Blade Cutter, 1 3/4" (45 mm)	97915
	63060	T-216	Chain Knocker, 2" (50 mm)	98000
	63065	T-217	Drop Head Auger, 4" (110 mm) Long	-
	55457	T-225	Retrieving Auger	-
	12128	T-240	Tool Set (3/8" - K-380): T-202 Bulb Auger, T-211 Spade Cutter, A-13 Pin Key	-
	49002	T-260	Tool Set (3/8" (10 mm) - K-400) Includes: - T-202 Bulb Auger - T-205 "C" Cutter - T-211 Spade Cutter - A-13 Pin Key	-

Tools Fit 1/2" (12mm) IC Cables

	Catalog No.	Model No.	Description	Replac. Blade(s)
	62850	T-101	Straight Auger	-
	62855	T-102	Funnel Auger	-
	62865	T-104	"H" Cutter, 2 1/2" (65 mm)	97800
	62870	T-105	Grease Cutter, 2 1/2" (65 mm)	97920
	62875	T-106	Grease Cutter, 3 1/2" (87 mm)	97925
	62880	T-107	Spade Cutter, 1 3/4" (45 mm)	92850
	62930	T-112	4-Blade Cutter, 1 3/4" (45 mm)	97915
	62935	T-113	4-Blade Cutter, 3" (75 mm)	97910
	62940	T-114	Chain Knocker for 4" lines	97985
	27642	T-125	Straight Retrieving Auger	-
	54842	T-141	Knife Blade Cutter 1 1/2" (40 mm)	54847
	54852	T-142	Knife Blade Cutter 2 1/2" (65 mm)	97800
	54992	T-270	Tool Set: - T-102 Funnel Auger - T-142 Knife Blade Cutter - T-107 Spade Cutter - A-12 Pin Key	-
	92687		Drop Head Tool Adaptor 1/2" (12 mm)	-

Drum Machines



K-6200 DRUM MACHINE

- 3" to 6" (75 to 150 mm) Drain/Sewer Lines Up to 200' (61 m)
- K-6200 machines offer superior maneuverability and a small footprint allows easy access to tight work areas. It comes equipped with either Inner Core cable or Integral Wound cable. Recommend 5/8" (16 mm) cable for 3" (75 mm) to 6" (150 mm) drain lines up to 200' (61 m).
- **Cable Control System** – causes the drum to stop spinning when the blade becomes lodged in a blockage, limits potential for cable to flip-over in the drum and helps indicate to operator when blockages are encountered.
- **Direct Drive Design** – 4/10 HP universal motor and gearbox bear down as torque builds. Audible warnings let operator know when blockage is encountered. Drum requires no adjustments to stay aligned and tight on drive shaft.
- **Easy Maintenance Construction** – Separate drum and machine in seconds. Inner drum and guide tube remove easily to maintain or replace cable.
- **Designed Durable and Stable** – Low center of gravity frame design and custom kickstand keep machine firmly anchored during operation. Rugged, corrosion-resistant polyethylene drum is rust and dent proof. Double tubular frame is lightweight and designed for extra strength.
- **AUTOFEED® Control and Standard Accessories** – Powerful feed mechanism is built to last and is easily maintained. AUTOFEED control, toolbox and selection of cutters included in all models.

SPECIFICATIONS

- **Line Capacity** – 3"- 6" (75-150 mm) Lines, up to 200' (61 m)
- **Drum Capacity** – 100' (30.5 m) of 5/8" (16 mm) cable
- **Weight (Machine & 100' (30.5 m) of Cable)** – 180 lbs. (81.6 kg)
- **Size** – Length 29 1/2" (75 cm, Height 43 1/2" (110 cm) (max.), Width 18 3/4", (47 cm)

MOTOR

- **Type** – 115V/60 Hz, 5.6 Amp, Reversible, Universal AC Motor
- **Rating** – 4/10 HP, 285 RPM
- **Machine Options**

Catalog No.	Model No.	Description	Weight	
			lb.	kg
93557	K-6200 with C-24 HD Cable	Machine, Standard Accessories and 5/8" x 100' (16 mm x 30.5 m) HD Solid Core Cable	180	81.8
95732	K-6200 with C-24	Machine, Standard Accessories and 5/8" x 100' (16 mm x 30.5 m) Inner Core Cable		
95737	K-6200	Machine with 5/8" (16 mm) Pigtail & Standard Accessories	98	44.5















Standard Equipment

Catalog No. Model No.	Description	93557 K-6200 w/C24 HD Cable	95732 K-6200 w/C-24	95737 K-6200
58192	5/8" (16 mm) x 100' HC Cable (30.5m)			
59360	Tool Box			
70032	RIDGID PVC Drain Cleaning Gloves			
92495	Spade Cutter, 1 3/4" (45 mm)			
92510	Double Cutter, 2" (50 mm)			
92520	Double Cutter, 3" (75 mm)			
92525	Double Cutter, 4" (110 mm)			
92555	5/8" (16 mm) x 2' (50 mm) Leader			

Cables and Leaders

	Catalog No.	Model No.	Description	Weight	
				lb.	kg
	37628	C-25 HD	25' HD Cable (7.6m)	24	10.9
	37633	C-26 HD	50' HD Cable (15.2m)	43	19.5
	37638	C-27 HD	75' HD Cable (30.5m)	63	28.6
	37643	C-24 HD	100 HD Cable (30.5m)	84	38.1
	44122		5/8" (16 mm) Pigtail, 4 1/2' (1.4 m) Long	2 1/2	1.1
	58192	C-24HC	5/8" (16 mm) x 100' HC Cable (30.5 m)	70 1/2	32.1
	43647	C-24	5/8" (16 mm) x 100' IC Cable (30.5m)	84	38.1
	92460	C-25	5/8" (16 mm) x 25' IC Cable (7.6m)	24	10.9
	92465	C-26	5/8" (16 mm) x 50' IC Cable (15.2m)	43	19.5
	92470	C-27	5/8" (16 mm) x 75' IC Cable (22.9m)	63	28.6
	92555	T-458	5/8" (16 mm) x 2' (50 mm) Leader	2	0.8
	32737	C-27HC	5/8" (16 mm) x 75' HC Cable (23 m)	52 3/4	23.9

Tools and Replacement Blades – Fit 5/8" (16 mm) and 3/4" (20 mm) Cables

	Catalog No.	Model No.	Description	Replac. Blade(s)	Replac. Holder
	51762	T-409	H-D Bulb Auger, 1 3/4" (45 mm)	-	-
	92485	T-403	P-Trap Cutter, 3" (75 mm)	92835	92900
	92490	T-404	P-Trap Cutter, 3 1/2" (87 mm)	92840	92900
	92495	T-406	Spade Cutter, 1 3/4" (45 mm)	92850	92915
	92500	T-407	Retrieving Auger 2 9/16" (65 mm)	-	-
	92505	T-408	Sawtooth Cutter, 3" (75 mm)	92890	92915
	92510	T-411	Double Cutter, 2" (50 mm)	92815	92905
	92515	T-412	Double Cutter, 2 1/2" (65 mm)	92820	92905
	92520	T-413	Double Cutter, 3" (75 mm)	92825	92910
	92525	T-414	Double Cutter, 4" (110 mm)	92830	92910
	92530	T-416	Double Cutter, 6" (150 mm)	92855	92910
	92535	T-432	3-Blade Cutter 2" (50 mm)	92860	92895
	92545	T-434	3-Blade Cutter 4" (110 mm)	92870	92895
	92550	T-436	3-Blade Cutter 6" (150 mm)	92875	92895
	59230	A-13	5/8" Cable Pin Key	-	-

Accessories

Catalog No.	Description
92540	3-Blade Cutter 3" (75 mm)
49032	Front Guide Hose Assembly
59360	Tool Box
70032	RIDGID® PVC Drain Cleaning Gloves
91047	5/8" IW Cable Repair Coupling
95792	Swivel Loading Wheel Assembly
95797	Lifting Hook - K-6200
95802	K-6200 Drum Assy. w/5/8" Pigtail
95807	K-3800 Drum Assy. w/6200 Adapters
95812	AUTOFEED® Assembly
95822	K-3800 to K-6200 Adapter Kit Only

Drum Machines



K-750 DRUM MACHINE

- 3" to 8" (75 to 200 mm) Drain/Sewer Lines
- Recommend 5/8" (16 mm) cable for 3" to 6" (75 to 150 mm) drain lines up to 150' (48 m).
- Recommend 3/4" (20 mm) cable for 4" to 8" (100 to 200 mm) drain lines up to 200' (62 m).
- Powerful, self-contained machine ideal for lateral lines. Easy to transport, minimal set-up – attach a tool and go.
- AUTOFEED control advances and retrieves cable with a push of a lever, up to 20' (6 m) per minute.
- Versatile AUTOFEED control adjusts for either 5/8" (16 mm) or 3/4" (20 mm) cable with a twist of a screwdriver.
- Tough, corrosion-resistant cable drum withstands harsh treatment and abuse. It will not dent or corrode and cleans easily.
- Drum holds 100' (30.5 m) of 3/4" (20 mm) or 125' (35 m) of 5/8" (16 mm) cable and is designed for quick, easy removal.
- Balanced design gives the machine a lightweight "feel." Transport wheels ease loading into service truck/van.
- Equipped with 1/2 HP induction motor that spins cable at 200 RPM.
- Includes RIDGID® PVC drain cleaning gloves and operators manual.

Machine Options

Catalog No.	Model No.	Description	Voltage		Weight	
			V	lb.	kg	
41977	K-750	Machine with Gloves and AUTOFEED - 3/4" (20 mm) Pigtail	115	114	51.9	
51402		Machine with Gloves and AUTOFEED - 5/8" (16 mm) Pigtail	115	113	51.3	
42002	K-750 with C-75	Machine with One Pair of Gloves, AUTOFEED, Standard 3/4" (20 mm) Tool Set, and: C-75, 75' (23 mm) x 3/4" (20 mm) Cable	115	206	93.6	
42007	K-750	Machine with One Pair of Gloves, w/C-100 AUTOFEED, Standard 3/4" (20 mm) Tool Set, and: C-100, 100' (30.5 mm) x 3/4" (20 mm) Cable	115	234	106.3	
42012	K-750 with C-27	Machine with One Pair of Gloves, AUTOFEED, Standard 5/8" (16 mm) Tool Set, and: C-27, 75' (23 mm) x 5/8" (16 mm) Cable	115	182	82.7	
47047	K-750 with C-24	Machine with One Pair of Gloves, AUTOFEED, Standard 5/8" (16 mm) Tool Set, and: C-24, 100' (30.5 mm) x 5/8" (16 mm) Cable	115			
44202	K-750	Machine with Gloves and AUTOFEED - 3/4" (20 mm) Pigtail	230	114	51.9	
51407		Machine with Gloves and AUTOFEED - 5/8" (16 mm) Pigtail	230	113	51.3	
44212		Machine with One Pair of Gloves, w/C-100 AUTOFEED, Standard 3/4" (20 mm) Tool Set, and: C-100, 100' (30.5 mm) x 3/4" (20 mm) Cable	230	234	106.3	
44217	K-750 with C-27	Machine with One Pair of Gloves, AUTOFEED, Standard 5/8" (16 mm) Tool Set, and: C-27, 75' (23 mm) x 5/8" (16 mm) Cable	230	182	82.7	

Standard Equipment

Catalog No. Model No.	Description	41977 K-750	51402 K-750	42002 K-750 w/C-75	42007 K-750	42012 K-750 w/C-27	47047 K-750 w/C-24	44202 K-750	51407 K-750	44212 K-750	44217 K-750 w/C-27
41937	RIDGID Leather Drain Cleaning Gloves										
41212	3/4" (20 mm) x 75' IC Cable (22.9m)										
92495	Spade Cutter, 1 1/4" (45 mm)										
92500	Retrieving Auger 2 3/8" (65 mm)										
92510	Double Cutter, 2" (50 mm)										
92520	Double Cutter, 3" (75 mm)										
92525	Double Cutter, 4" (110 mm)										
41697	3/4" (20 mm) x 100' IC Cable (30.5m)										
92470	5/8" (16 mm) x 75' IC Cable (22.9m)										
92485	P-Trap Cutter, 3" (75 mm)										
43647	5/8" (16 mm) x 100' IC Cable (30.5m)										



Inner Core (IC) Cables

	Catalog No.	Model No.	Description	Weight	
				lb.	kg
5/8" - 16 mm	92460	C-25	5/8" (16 mm) x 25' IC Cable (7.6m)	24	10.9
	92465	C-26	5/8" (16 mm) x 50' IC Cable (15.2m)	43	19.5
	92470	C-27	5/8" (16 mm) x 75' IC Cable (22.9m)	63	28.6
	43647	C-24	5/8" (16 mm) x 100' IC Cable (30.5m)	84	38.1
	37643	C-24HD	5/8" (16 mm) x 100' Heavy Duty Cable (30.5m)	85	38.6
3/4" - 20 mm	92475	C-28	3/4" (20 mm) x 25' IC Cable (7.6m)	30	13.9
	92480	C-29	3/4" (20 mm) x 50' IC Cable (15.2m)	60	27.2
	41212	C-75	3/4" (20 mm) x 75' IC Cable (22.9m)	93	42.5
	41697	C-100	3/4" (20 mm) x 100' IC Cable (30.5m)	122	55.3







Hollow Core Cables

	Catalog No.	Model No.	Description	Weight	
				lb.	kg
5/8" - 16 mm	32737	C-27HC	5/8" (16 mm) x 75' HC Cable (23 m)	52 3/4	23.9
	58192	C-24HC	5/8" (16 mm) x 100' HC Cable (30.5 m)	70 1/2	32.1
3/4" - 20 mm	47427	C-75HC	3/4" (20 mm) x 75' HC Cable (23 m)	75	34.0
	47432	z-100HC	3/4" (20 mm) x 100' HC Cable (30.5 m)	100	45.5



Leaders and Pig Tails

	Catalog No.	Model No.	Description	Weight	
				lb.	kg
	92555	T-458	5/8" (16 mm) x 2' (50 mm) Leader	2	0.9
	92560	T-468	3/4" (20 mm) x 2' (50 mm) Leader	2 3/4	1.3
	44122	-	5/8" (16 mm) Pigtail, 4 1/2' (1.4 m) Long	2 1/2	1.1
	44117	-	3/4" Pigtail Assembly	3 1/2	1.6















Accessories

	Catalog No.	Model No.	Description	Weight	
				lb.	kg
	41982	A-7534	Drum Assembly with 3/4" (20 mm) Pigtail	37 1/2	17.0
	43637	A-7558	Drum Assembly with 5/8" (16 mm) Pigtail	33	15.0
	43642	A-75	AUTOFEED Assembly	8	3.5
	41937	-	RIDGID® Leather Drain Cleaning Gloves	1/2	0.2
	41992	A-75PF	C-100IC Kit with Tools, 3/4" (20 mm) x 100' (30,5 m)	8	3.5
	49032		Front Guide Hose Assembly	3	1.3
	59360	A-3	Tool Box	5	2.3
	70032	-	RIDGID® PVC Drain Cleaning Gloves	1/2	0.2
	46015		Key, Hex 5/32	-	-

Repair Fittings

	Catalog No.	Model No.	Description	Weight	
				lb.	kg
	31487	A-7570	5/8" (16 mm) Repair Splicer	1 1/2	43.0
	31492	A-7571	3/4" (20 mm) Repair Splicer	2	57.0
	92805	A-6582	5/8" (16 mm) Male Coupling	1	28.0
	92810	A-6583	5/8" (16 mm) Female Coupling	2	57.0
	92880	B-6840	3/4" (20 mm) Male Coupling	1	28.0
	92885	B-6841	3/4" (20 mm) Female Coupling	2	57.0

Tools and Replacement Blades – Fit 5/8" (16 mm) and 3/4" (20 mm) Cables

	Catalog No.	Model No.	Description	Replac. Blade(s)	Replac. Holder
	92485	T-403	P-Trap Cutter, 3" (75 mm)	92835	92900
	92490	T-404	P-Trap Cutter, 3 1/2" (87 mm)	92840	92900
	92495	T-406	Spade Cutter, 1 3/4" (45 mm)	92850	92915
	92500	T-407	Retrieving Auger 2 3/16" (65 mm)	-	-
	92505	T-408	Sawtooth Cutter, 3" (75 mm)	92890	92915
	51762	T-409	H-D Bulb Auger, 1 3/4" (45 mm)	-	-
	92510	T-411	Double Cutter, 2" (50 mm)	92815	92905
	92515	T-412	Double Cutter, 2 1/2" (65 mm)	92820	92905
	92520	T-413	Double Cutter, 3" (75 mm)	92825	92910
	92525	T-414	Double Cutter, 4" (110 mm)	92830	92910
	92530	T-416	Double Cutter, 6" (150 mm)	92855	92910
	92535	T-432	3-Blade Cutter 2" (50 mm)	92860	92895
	92540	T-433	3-Blade Cutter 3" (75 mm)	92865	92985
	92545	T-434	3-Blade Cutter 4" (110 mm)	92870	92895
	92550	T-436	3-Blade Cutter 6" (150 mm)	92875	92895

*STANDARD 3/4" (20 MM) TOOL SET INCLUDES

- T-406 Spade Cutter - 92495
- T-407 Retrieving Auger - 92500
- T-411 2" (50 mm) Cutter - 92510
- T-413 3" (75 mm) Cutter - 92520
- T-414 4" (110 mm) Cutter - 92525
- Hex Key - 46015

*STANDARD 5/8" (16 MM) TOOL SET INCLUDES

- T-403 3" (75 mm) P-Trap Cutter - 92485
- T-407 Retrieving Auger - 92500
- T-406 Spade Cutter - 92495
- T-411 2" (50 mm) Cutter - 92510
- T-413 3" (75 mm) Cutter - 92520
- Hex Key - 46015

*Sold Separately

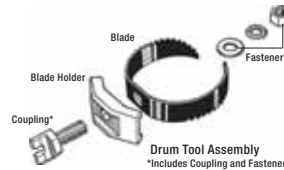

Drum Machines



K-7500 DRUM MACHINE

- 3" to 10" (75-250 mm) Lines
- Recommend 5/8" (16 mm) cable for 3" (75 mm) to 6" (150 mm) drain lines up to 250' (76 m).
- Recommend 3/4" (20 mm) cable for 4" (110 mm) to 10" (250 mm) drain lines up to 250' (76 m).
- Features performance, durability and maneuverability demanded by professional users. Ideal for tough jobs, such as roots.
- Cable Control System – causes the drum to stop spinning when the blade becomes lodged in a blockage, limits potential for cable to flip-over in the drum and helps indicate to operator when blockages are encountered.
- Powerful, yet quiet, 4/10 HP universal motor and gearbox spins cable at 200 RPM.
- Audible and visual signals for the operator.
- Main and inner drums won't rust, split or dent – ever. Cleans easily for professional appearance. Main drum holds up to 100' (30.5 m) of 3/4" (20 mm) cable, or 125' (38 m) of 5/8" (16 mm) cable.
- Powerful AUTOFEED® mechanism has grease fittings and an open design for easy maintenance. It advances and retrieves cable up to 22' (6.7 m) per minute.
- Two position stair climber eases transport and loading – to eliminate extra cost for loading wheels.
- Narrow profile lets the machine to fit through bathroom doors.
- Handles adjust to desired height to ensure balanced transport.
- Includes RIDGID® PVC drain cleaning gloves and operator's manual.

Machine Options

Catalog No.	Model No.	Description	Voltage		Weight	
			V	lb.	kg	
59562	K-7500	Machine with 3/4" (20 mm) Pigtail and Standard Accessories	115	150	86.2	
60052	K-7500 C-100	Machine, Standard Accessories, and 3/4" x 100' (20 mm x 30.5 m) Inner Core Cable.	115	272	123.7	
60062	K-7500 w/C-75	Machine, Standard Accessories, and 3/4" x 75' (20 mm x 22.9 m) Inner Core Cable.	115	244	110.9	
61102	K-7500	Machine with 5/8" (16 mm) Pigtail and Standard Accessories	115	149	67.8	
61522		Machine with 5/8" (16 mm) Pigtail and Standard Accessories	220			
61542		Machine with 3/4" (20 mm) Pigtail and Standard Accessories	220			150

Standard Equipment

Catalog No. Model No.	Description	59562 K-7500	60052 K-7500 C-100	60062 K-7500 w/C-75	61102 K-7500	61522 K-7500	61542 K-7500
59360	Tool Box						
69250	3/16" Hex Wrench						
70032	RIDGID PVC Drain Cleaning Gloves						
92485	P-Trap Cutter, 3" (75 mm)						
92495	Spade Cutter, 1 3/4" (45 mm)						
92500	Retrieving Auger 2 3/16" (65 mm)						
92505	Sawtooth Cutter, 3" (75 mm)						
92510	Double Cutter, 2" (50 mm)						
92520	Double Cutter, 3" (75 mm)						
92560	3/4" (20 mm) x 2' (50 mm) Leader						
92830	4" Double Cutter (Blade Only)						
92855	6" Double Cutter (Blade Only)						
41697	3/4" (20 mm) x 100' IC Cable (30.5m)						
41212	3/4" (20 mm) x 75' IC Cable (22.9m)						

Cable Control & Performance – When Tool Engages Tough Obstructions

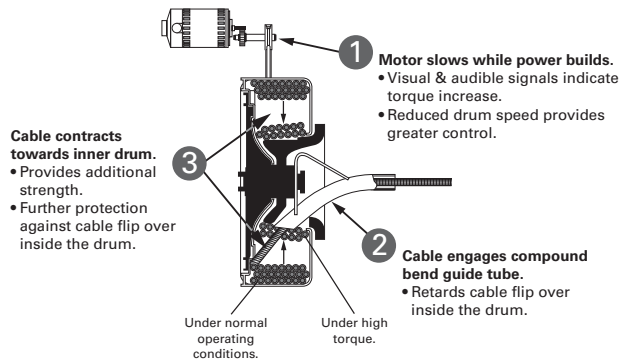

Accessories

	Catalog No.	Model No.	Description	Weight	
				lb.	kg
	41937	-	RIDGID® Leather Drain Cleaning Gloves	1/2	0.2
	41992	A-75PF	C-100IC Kit with Tools, 3/4" (20 mm) x 100' (30.5 m)	8	3.5
	49032		Front Guide Hose Assembly	3	1.3
	59360	A-3	Tool Box	5	2.3
	60032		AUTOFEED® Assembly		
	60037	A-75PF	AUTOFEED® Spacers (4)	10	4.5
	60042	A-7534D	Drum Assembly w/3/4" (20 mm) Pigtail	31	14.0
	60047	A-75DR	Drum Only	20	9.0
	61107	A-7558D	Drum Assembly w/5/8" (16 mm) Pigtail	30	13.6
	70032	-	RIDGID® PVC Drain Cleaning Gloves	1/2	0.2
	31487	A-7570	5/8" (16 mm) Repair Splicer	3/32	0.0
	31492	A-7571	3/4" (20 mm) Repair Splicer	1/8	0.1
	92805	A-6582	5/8" (16 mm) Male Coupling	1/16	0.0
	92810	A-6583	5/8" (16 mm) Female Coupling	1/8	0.1
	92880	B-6840	3/4" (20 mm) Male Coupling	1/16	0.0
	92885	B-6841	3/4" (20 mm) Female Coupling	1/8	0.1

Inner Core (IC) Cables

	Catalog No.	Model No.	Description	Weight	
				lb	kg
5/8" - 16 mm	92460	C-25	5/8" (16 mm) x 25' IC Cable (7.6m)	24	10.9
	92465	C-26	5/8" (16 mm) x 50' IC Cable (15.2m)	43	19.5
	92470	C-27	5/8" (16 mm) x 75' IC Cable (22.9m)	63	28.6
	43647	C-24	5/8" (16 mm) x 100' IC Cable (30.5m)	84	38.1
3/4" - 20 mm	92475	C-28	3/4" (20 mm) x 25' IC Cable (7.6m)	30	13.9
	92480	C-29	3/4" (20 mm) x 50' IC Cable (15.2m)	60	27.2
	41212	C-75	3/4" (20 mm) x 75' IC Cable (22.9m)	93	42.5
	41697	C-100	3/4" (20 mm) x 100' IC Cable (30.5m)	122	55.3

Hollow Core Cables

	Catalog No.	Model No.	Description	Weight	
				lb	kg
5/8" - 16 mm	32737	C-27HC	5/8" (16 mm) x 75' HC Cable (23 m)	52 3/4	23.9
	58192	C-24HC	5/8" (16 mm) x 100' HC Cable (30.5 m)	70 1/2	32.1
3/4" - 20 mm	47427	C-75HC	3/4" (20 mm) x 75' HC Cable (23 m)	75	34.0
	47432	C-100HC	3/4" (20 mm) x 100' HC Cable (30.5 m)	100	45.5

Leaders and Pig Tails

	Catalog No.	Model No.	Description	Weight	
				lb	kg
	92555	T-458	5/8" (16 mm) x 2' (50 mm) Leader	2	0.9
	92560	T-468	3/4" (20 mm) x 2' (50 mm) Leader	2 3/4	1.3
	44122		5/8" (16 mm) Pigtail, 4 1/2' (1.4 m) Long	2 1/2	1.1
	44117		3/4" Pigtail Assembly	3 1/2	1.6

Tools and Replacement Blades – Fit 5/8" (16 mm) and 3/4" (20 mm) Cables

	Catalog No.	Model No.	Description	Replac. Blade(s)	Replac. Holder
	51762	T-409	H-D Bulb Auger, 1 3/4" (45 mm)	-	-
	92485	T-403	P-Trap Cutter, 3" (75 mm)	92835	92900
	92490	T-404	P-Trap Cutter, 3 1/2" (87 mm)	92840	92900
	92495	T-406	Spade Cutter, 1 3/4" (45 mm)	92850	92915
	92500	T-407	Retrieving Auger 2 9/16" (65 mm)	-	-
	92505	T-408	Sawtooth Cutter, 3" (75 mm)	92890	92915
	92510	T-411	Double Cutter, 2" (50 mm)	92815	92905
	92515	T-412	Double Cutter, 2 1/2" (65 mm)	92820	92905
	92520	T-413	Double Cutter, 3" (75 mm)	92825	92910
	92525	T-414	Double Cutter, 4" (110 mm)	92830	92910
	92530	T-416	Double Cutter, 6" (150 mm)	92855	92910
	92535	T-432	3-Blade Cutter 2" (50 mm)	92860	92895
	92540	T-433	3-Blade Cutter 3" (75 mm)	92865	92895
	92545	T-434	3-Blade Cutter 4" (110 mm)	92870	92895
	92550	T-436	3-Blade Cutter 6" (150 mm)	92875	92895

C-24, C-25, C-26, C-27, C-28, C-29, C-75, C-100, C-27HC, C-24HC, C-75HC and C-100HC.

Drum Machines



K-750R DRUM MACHINE

- 3" to 6" (75 mm to 150 mm) Drain Lines
- The K-750R is a self-contained drain cleaner ideal for lateral drain lines from 3" to 6" (75 mm to 150 mm). Easy-to-transport, narrow design for small entry ways and minimal setup make this machine ideal for tough mainline work. Comes equipped with a large blade assortment to handle numerous applications. Clears roots, debris and foreign objects out of main lines, storm drains, house laterals and leach lines.
- Clear access to drum allows immediate view of cable for inspection plus easier and faster cleaning of drum and cable.
- Cable Control System – causes the drum to stop spinning when the blade becomes lodged in a blockage, limits potential for cable to flip-over in the drum and helps indicate to operator when blockages are encountered.
- New integral-wound, solid core cable is tough and kink resistant. 5/8" x 100' (16 mm x 30.5 m).
- Dual kickstands.
- New torque limiter feature.
- Lean, balanced design for easy one-man transport and operation.

SPECIFICATIONS

- **Motor** – 1/2 HP, 115V, 60Hz reversible induction motor, 200 RPM
- **Control** – Air activated foot switch

Catalog No.	Model No.	Description	Weight	
			lb	kg
83557	K-750R	5/8" (16 mm) Open Cage Drum Machine with 5/8" x 100' (16 mm x 30.5 m) IW Solid Core Cable; 2", 3", 4" "C" Cutters; P-Trap Cutter; Spade Blade; Tool Box; Gloves.	194	98.0

Standard Equipment

Catalog No. Model No.	Description	83557 K-750R
37753	5/8" x 100' Heavy Duty Inner Core Cable; Rental Tool; Special Coupling with Mounting Bolt	
59360	Tool Box	
92485	P-Trap Cutter, 3" (75 mm)	
92495	Spade Cutter, 1 3/4" (45 mm)	
92510	Double Cutter, 2" (50 mm)	
92520	Double Cutter, 3" (75 mm)	
92525	Double Cutter, 4" (110 mm)	















Inner Core (IC) Cables

	Catalog No.	Model No.	Description	Weight	
				lb	kg
5/8" - 16 mm	92460	C-25	5/8" (16 mm) x 25' IC Cable (7.6m)	24	10.9
	92465	C-26	5/8" (16 mm) x 50' IC Cable (15.2m)	43	19.5
	92470	C-27	5/8" (16 mm) x 75' IC Cable (22.9m)	63	28.6
	43647	C-24	5/8" (16 mm) x 100' IC Cable (30.5m)	84	38.1
3/4" - 20 mm	92475	C-28	3/4" (20 mm) x 25' IC Cable (7.6m)	30	13.9
	92480	C-29	3/4" (20 mm) x 50' IC Cable (15.2m)	60	27.2
	41212	C-75	3/4" (20 mm) x 75' IC Cable (22.9m)	93	42.5
	41697	C-100	3/4" (20 mm) x 100' IC Cable (30.5m)	122	55.3



Hollow Core Cables

	Catalog No.	Model No.	Description	Weight	
				lb	kg
5/8" - 16 mm	32737	C-27HC	5/8" (16 mm) x 75' HC Cable (23 m)	52 3/4	23.9
	58192	C-24HC	5/8" (16 mm) x 100' HC Cable (30.5 m)	70 1/2	32.1
3/4" - 20 mm	47427	C-75HC	3/4" (20 mm) x 75' HC Cable (23 m)	75	34.0
	47432	C-100HC	3/4" (20 mm) x 100' HC Cable (30.5 m)	100	45.5

Tools and Replacement Blades – Fit 5/8" (16 mm) and 3/4" (20 mm) Cables

	Catalog No.	Model No.	Description	Replac. Blade(s)	Replac. Holder
	51762	T-409	H-D Bulb Auger, 1 3/4" (45 mm)	-	-
	92485	T-403	P-Trap Cutter, 3" (75 mm)	92835	92900
	92490	T-404	P-Trap Cutter, 3 1/2" (87 mm)	92840	92900
	92495	T-406	Spade Cutter, 1 3/4" (45 mm)	92850	92915
	92500	T-407	Retrieving Auger 2 9/16" (65 mm)	-	-
	92505	T-408	Sawtooth Cutter, 3" (75 mm)	92890	92915
	92510	T-411	Double Cutter, 2" (50 mm)	92815	92905
	92515	T-412	Double Cutter, 2 1/2" (65 mm)	92820	92905
	92520	T-413	Double Cutter, 3" (75 mm)	92825	92910
	92525	T-414	Double Cutter, 4" (110 mm)	92830	92910
	92530	T-416	Double Cutter, 6" (150 mm)	92855	92910
	92535	T-432	3-Blade Cutter 2" (50 mm)	92860	92895
	92540	T-433	3-Blade Cutter 3" (75 mm)	92865	92895
	92545	T-434	3-Blade Cutter 4" (110 mm)	92870	92895
	92550	T-436	3-Blade Cutter 6" (150 mm)	92875	92895

Leaders and Pig Tails

	Catalog No.	Model No.	Description	Weight	
				lb	kg
	92555	T-458	5/8" (16 mm) x 2' (50 mm) Leader	2	0.9
	92560	T-468	3/4" (20 mm) x 2' (50 mm) Leader	2 3/4	1.3
	44122	-	5/8" (16 mm) Pigtail, 4 1/2' (1.4 m) Long	2 1/2	1.1
	44117	-	3/4" Pigtail Assembly	3 1/2	1.6

Accessories

Catalog No.	Model No.	Description	Weight	
			lb	kg
41982	A-7534	Drum Assembly with 3/4" (20 mm) Pigtail	37 1/2	17.0
43637	A-7558	Drum Assembly with 5/8" (16 mm) Pigtail	33	15.0
43642	A-75	AUTOFEED Assembly	8	3.5
41937	-	RIDGID® Leather Drain Cleaning Gloves	1/2	0.2
41992	A-75PF	C-100IC Kit with Tools, 3/4" (20 mm) x 100' (30.5 m)	8	3.5
49032	-	Front Guide Hose Assembly	3	1.3
59360	A-3	Tool Box	5	2.3
70032	-	RIDGID® PVC Drain Cleaning Gloves	1/2	0.2

Repair Fittings

	Catalog No.	Model No.	Description	Weight	
				lb	kg
	31487	A-7570	5/8" (16 mm) Repair Splicer	1 1/2	43.0
	31492	A-7571	3/4" (20 mm) Repair Splicer	2	57.0
	92805	A-6582	5/8" (16 mm) Male Coupling	1	28.0
	92810	A-6583	5/8" (16 mm) Female Coupling	2	57.0
	92880	B-6840	3/4" (20 mm) Male Coupling	1	28.0
	92885	B-6841	3/4" (20 mm) Female Coupling	2	57.0

Sectional Machines



K-50 SECTIONAL MACHINE

- 3/4" to 4" (20 mm to 110 mm) drain lines.
- Compact, versatile professional's machine. Capable of running three different size cables: 5/16" (8 mm), 3/8" (10 mm) and 5/8" (16 mm). The perfect, all-around sink, shower and floor drain machine. Weighs less than 40 lbs (18 kg).
- Uses sections of 5/8" (16 mm) cable, cleans 1 1/4" to 4" (32 mm to 110 mm) lines up to 100 feet.
- C-8 best for 1 1/4" to 3" (32 mm to 75 mm) drains.
- C-9 best for 2" to 4" (50 mm to 110 mm) drains.
- Equipped with an A-17 drum adapter for runs up to 50' (15 m) of 5/16" (8 mm) cable or, 35' (11 m) of 3/8" (10 mm) continuous length cable.
- 5/16" (8 mm) best for 3/4" (20 mm) to 1 1/2" (40 mm) lines.
- 3/8" (10 mm) best for 1 1/4" (32 mm) to 2" (50 mm) lines.
- Unique, easy-to-use, instant-acting cable clutch maximizes operator control.
- Equipped with 1/6 HP motor that spins cable at 400 RPM.
- Includes A-1 RIDGID® drain cleaning mitt and operator's manual.

Machine Options

Catalog No.	Model No.	Description	Voltage		
			V	lb	kg
58920	K-50	Machine Only	115	37	16.8
58960	K-50-4	Machine, with A-30 Cable Kit	115	61	27.7
58980	K-50-6	Machine, with -17-A Adapter, A-30 Cable Kit	115	67	30.4
59000	K-50-8	Machine, with A-17-A Adapter, A-17-B Adapter, A-30 Cable Kit	115	77	34.9
52972	K-50-9	Machine, with A-40 Cable Kit	115	74	33.6
76455	K-50	Machine Only	230	37	16.8
76475	K-50-4	Machine, with A-30 Cable Kit	230	61	27.7
76485	K-50-6	Machine, with -17-A Adapter, A-30 Cable Kit	230	67	30.4
76495	K-50-8	Machine, with A-17-A Adapter, A-17-B Adapter, A-30 Cable Kit	230	77	34.9

Model K-50-8 shown below includes:

- K-50 Machine
- A-17-A, Drum Adapter includes: 25' x 5/16", C-1 Bulb Auger Cable
- A-17-B, Drum Adapter includes: 35' x 3/8", C-5 Bulb Auger Cable
- A-1 RIDGID Drain Cleaning Mitt



A-30 Cable Kit Includes:

- Six Sections C-8, 7 1/2' x 5/8" Cable (45 feet).
- A-10 Cable Carrier
- T-201 Straight Auger
- T-202 Bulb Auger
- T-205 "C" Cutter
- T-211 Spade Cutter
- A-13 Coupling Pin Key
- A-14-6 Rear Guide Hose
- A-1 Left-Hand RIDGID Drain Cleaning Mitt

Cables

	Catalog No.	Model No.	Description	Weight	
				lb.	kg
5/8" - 16 mm	62265	C-7	5/8" (16 mm) x 7 1/2' (2,3 m) Tight-Wind	4	1.8
	62270	C-8	5/8" (16 mm) x 7 1/2' (2,3 m) All-Purpose Wind	3	1.4
	51317	C-9	5/8" (16 mm) x 10' (3,1 m) Heavy-Duty Wind	5	2.2
3/8" - 10 mm	62245	C-4	3/8" (10mm) x 25' (7,6 m) with Male Coupling	4 1/2	2.0
	62250	C-5	3/8" (10mm) x 35' (10,7 m) with Bulb Auger	8 1/4	3.8
	62260	C-6	3/8" (10 mm) x 35' (10,7 m) with Male Coupling	8 1/2	4.0
	96037	C-6IC	3/8" (10mm) x 35' (10,7 m) Inner Core with Male Coupling	8 1/2	4.0
5/16" - 8 mm	62225	C-1	5/16" (8 mm) x 25' (7,6 m) with Bulb Auger	3 1/2	1.6
	56782	C-1IC	5/16" (8 mm) x 25' (7,6 m) Inner Core with Bulb Auger	4	1.8
	89400	C-21	5/16" (8 mm) x 50' (15,2 m) with Bulb Auger	7	3.2
	62235	C-2	5/16" (8 mm) x 25' (7,6 m) with Drop Head Auger	3 1/2	1.6
	56787	C-2IC	5/16" (8 mm) x 25' (7,6 m) Inner Core with Drop Head Auger	4	1.8
	89405	C-22	5/16" (8 mm) x 50' (15,2 m) with Drop Head Auger	7	3.2

Cable Kits

Image	Catalog No.	Model No.	Cable	Tools & Accessories	Weight	
					lb.	kg
	59365	A-30	Six Sections: C-8, 5/8"x7 1/2' (45', 13,7 m)	T-201 Straight Auger T-202 Bulb Auger T-205 "C" Cutter T-211 Spade Cutter A-13 Coupling Pin Key A-10 Cable Carrier A-14-6 Rear Guide Hose A-1 Left-Hand RIDGID Drain Cleaning Mitt	20	9.1
	52962	A-40	Six Sections: C-9, 5/8" x 10' (60', 18,3 m)	T-206 Funnel Auger T-215 4-Blade Cutter T-231 "C" Cutter A-13 Coupling Pin Key A-10 Cable Carrier A-14-10 Rear Guide Hose A-1 Left-Hand RIDGID Drain Cleaning Mitt	37	16.8
	59370	A-30TW	Six Sections: C-7, 5/8"x7 1/2' (45', 13,7m) Tight-Wind	Same as A-30	30	13.6

Drum Adapters

Image	Catalog No.	Model No.	Description	Weight	
				lb.	kg
	59250	A-17-A	Drum adapter With 25' (7,6 m) x 5/16" (8 mm) Cable w/Bulb Auger	8	3.6
	59255	A-17-B	Drum adapter With 35' (10,7 m) x 3/8" (10 mm) Cable w/Bulb Auger	13	5.9
	59265	A-17-C	Drum adapter With 35' x 3/8" Cable w/Male Coupling	12	5.4
	92095	A-17-D	Drum adapter With 50' x 5/16" Cable w/Bulb Auger		
	92100	A-17-E	Drum adapter With 25' x 5/16" Cable w/Drop Head		

Accessories

Image	Catalog No.	Model No.	Description	Weight	
				lb.	kg
	59235	A-14-6	6' (1,8 m) Rear Guide Hose	5	2.3
	84325	A-14-10	10' (3 m) Rear Guide Hose	7	3.2
	59270	A-18	Front Guide Hose Assembly	9	4.1
	59210	A-10	Cable Carrier Holds 90' (27 m) C-8, C-9	3 1/4	1.5
	59205	A-1	Left-Hand RIDGID Drain Cleaning Mitt		
	59295	A-2	Right-Hand RIDGID Drain Cleaning Mitt	1/2	0.2
	59230	A-13	3/8" Cable Pin Key		
	61718	-	Trident Sectional Cable Decoupler	3/4	0.3
	61708	-	Sectional Cable Carrier	33	15
	61713	-	Sectional Cable Drum	15	6.8
	59450	A-3179	A-3179 Clutch Jaw Assembly	1 1/2	0.7

Tools - Fits 3/8" Drum and 5/8" Sectional Cable

Image	Catalog No.	Model No.	Description	Replac. Blade(s)
	62067	T-201A	Straight Flex Auger	
	62995	T-202	Bulb Auger, 1 1/4" (29 mm) O.D.	
	63000	T-203	Bulb Auger 7/8" (22 mm) O.D.	
	54837	T-204	"C" Cutter 1" (25 mm)	54832
	63005	T-205	"C" Cutter, 1 3/8" (35 mm)	97835
	52812	T-230	H-D "C" Cutter, 2" (50 mm)	92815
	52817	T-231	H-D "C" Cutter, 2 1/2" (65 mm)	92820
	52822	T-232	H-D "C" Cutter, 3" (80 mm)	92835
	63010	T-206	Funnel Auger, 3" (80 mm) Long	
	63015	T-207	Spiral Cutter, 1 1/4" (32 mm)	97840
	63020	T-208	Spiral Cutter, 1 1/2" (40 mm)	97895
	63025	T-209	Spiral Cutter, 2" (50 mm)	97900
	63030	T-210	Spade Cutter, 1" (25 mm)	97905
	63035	T-211	Spade Cutter, 1 3/8" (35 mm)	97825
	63040	T-212	Spade Cutter, 1 3/4" (45 mm)	92850
	63045	T-213	4-Blade Cutter, 1" (25 mm)	97795
	63050	T-214	4-Blade Cutter, 1 3/8" (35 mm)	97910
	63055	T-215	4-Blade Cutter, 1 3/4" (45 mm)	97915
	63060	T-216	Chain Knocker, 2" (50 mm)	98000
	63065	T-217	Drop Head Auger, 4" (110 mm) Long	
	63280	T-218	Flue Brush, 3" (75 mm)	
	63070	T-219	Flue Brush, 2 1/2" (65 mm)	
	63080	T-220	Flue Brush, 2" (50 mm)	
	63220	T-221	Flue Brush, 1 1/2" (40 mm)	
	55457	T-225	Retrieving Auger	
	12128	T-240	Tool Set (3/8" - K-380): T-202 Bulb Auger, T-211 Spade Cutter, A-13 Pin Key	

Sectional Machines



K-60SP SECTIONAL MACHINE

- 1 1/4" to 4" (32-100 mm) Drain Lines
- Simple adjustment knob allows unit to spin both 7/8" (22 mm) and 5/8" (16 mm) diameter cable. Adjusts in seconds.
- 7/8" (22 mm) cable (C-10) cleans 2" to 4" (50 mm to 100 mm) lines through 150' (45.7 m).
- 5/8" (16 mm) cable (C-7, C-8, C-9) cleans 1 1/4" to 4" (32 mm to 100 mm) lines through 125' (38.1 m).
- A compact machine for institutional, commercial or residential cleaning. Also ideal for septic tank vacuum truck operators. Small enough to fit into cramped spaces, yet powerful enough to clear tough blockages.
- Ideal for rooftop vent stacks. Rear handle allows for easy transporting up ladders and onto rooftops.
- Remove only two bolts to access jaw set for cleaning or replacement. Removal of same bolts provides access to belt drive.
- Equipped with 1/2 HP motor that spins cable at 600 RPM.

Machine Options



Catalog No.	Model No.	Description	Voltage		
			V	lb	kg
66492	K-60SP	Machine with A-1 Operator's Mitt, A-12 Pin Key, and A-60-12 Rear Guide Hose	115	41	18.6
66497	K-60SP-SE	Machine with A-1 Operator's Mitt, A-12 Pin Key, and A-60-12 Rear, Guide Hose, plus: A-61 Tool Kit and A-62 Cable Kit	115	92	41.7
66512	K-60SP	Machine with A-1 Operator's Mitt, A-12 Pin Key, and A-60-12 Rear Guide Hose	230	41	18.6
66517	K-60SP-SE	Machine with A-1 Operator's Mitt, A-12 Pin Key, and A-60-12 Rear, Guide Hose, plus: A-61 Tool Kit and A-62 Cable Kit	230	92	41.7

K-60SP-SE shown below includes:

- K-60SP Machine
- A-1 RIDGID® Drain Cleaning Mitt
- A-60-12 Rear Guide Hose
- A-62 Cable Kit, includes:
 - A-8 Cable Carrier
 - Five Sections Of C-10, 7/8" Cable, Total 75 Feet
- A-61 Tool Kit, includes:
 - T-101 Straight Auger
 - T-102 Funnel Auger
 - T-107 Spade Cutter
 - T-125 Retrieving Auger
 - T-150-1 Sharktooth Cutter
 - A-3 Tool Box
 - A-12 Pin Key



Cables and Leaders

	Catalog No.	Model No.	Description	Weight	
				lb	kg
	62275	C-10	7/8" (22 m) x 15' (4,6 m) All- Purpose Wind Requires A-368-X Jawset	9 1/2	4.3
	25036	C-10 PC	7/8" (22 mm) x 15' Cable with Inner Core (4,6 m) Requires A-368-X Jawset	10	4.5
	30007	T-127	7/8" (22 mm) Trap Leader	2	0.9
	51317	C-9	5/8" (16 mm) x 10' (3,1 m) Heavy-Duty Wind	5	2.2
	62270	C-8	5/8" (16 mm) x 7 1/2' (2,3 m) All-Purpose Wind	3	1.4
	62265	C-7	5/8" (16 mm) x 7 1/2' (2,3 m) Tight-Wind	4	1.8

Cable Kits and Tool Kits

	Catalog No.	Model No.	Description	Weight	
				lb	kg
	61625	A-621	Standard Equipment Tool Kit for K-60-SE, includes: -T-101 Straight Auger -T-102 Funnel Auger -T-107 Spade Cutter -T-125 Retriving Auger -T-150-1 Sharktooth Cutter -A-3 Tool Box -A-12 Pin Key	43	19.5
	61630	A-62	Standard Equipment Cable Kit for K-60-SE, includes: - Five Sections C-10, 7/8" (22 mm) x 15' (4,6 m) Cable - A-8 Cable Carrier	8	3.6
	48472	A-35	5/8" Cable Kit, includes: Six Sections C-8, 5/8" x 7 1/2" Cable (45', 14m), A-10 Cable Carrier, T-201 Straight Auger, T-202 Bulb Auger, T-205 "C" Cutter, T-211 Spade Cutter, A-13 Coupling Pin Key	18	8.2
	48477	A-35TW	5/8" Tight-Wind Cable Kit, Substitutes C-7 For C-8 In, Above Package	-	-
	59365	A-30	Six Sections: C-8, 5/8"x7 1/2" (45', 13,7 m) T-201 Straight Auger T-202 Bulb Auger T-205 "C" Cutter T-211 Spade Cutter A-13 Coupling Pin Key A-10 Cable Carrier A-14-6 Rear Guide Hose A-1 Left-Hand RIDGID Drain Cleaning Mitt	20	9.1
	94492	A-25	5/8" (16 mm) Cable Kit, includes: Five Sections C-8, 5/8" (16 mm) x 7 1/2" (2,3 m) Cable 37.5' (11,5 m) -A-10 Cable Carrier -T-201 Straight Auger -T-202 Bulb Auger -T-205 "C" Cutter -A-13 Coupling Pin Key	18	8.2

Accessories

	Catalog No.	Model No.	Description	Weight	
				lb	kg
	59360	A-3	Tool Box	5	2.3
	59205	A-1	Left-Hand RIDGID Drain Cleaning Mitt	1/2	0.2
	59295	A-2	Right-Hand RIDGID Drain Cleaning Mitt		
	59230	A-13	3/8" Cable Pin Key		
	59225	A-12	1/2" Cable Pin Key	1/2	0.2
	61718	-	Trident Sectional Cable Decoupler	3/4	0.3
	61615	A-60-12	12' (3,7 m) Rear Guide Hose For K-60	12	5.5
	76575	A-60-16	16' (4,9 m) Rear Guide Hose For K-60	15 1/2	7.0
	59425	A-36	Cable Caddy	15	6.8
	61708	-	Sectional Cable Carrier	33	15
	61713	-	Sectional Cable Drum	15	6.8
	59210	A-10	Cable Carrier Holds 90' (27 m) C-8, C-9	3 1/4	1.5
	59470	A-8	Cable Carrier 60' (18 m) Capacity 1 1/4" (32 mm)	5 1/2	2.5
	59445	A-5	Grease Gun	1/2	0.2
	65687		Clutch Jaw	3/4	0.3

Tools - Fits 7/8" Sectional Cables

	Catalog No.	Model No.	Description	Replac. Blade(s)
	62850	T-101	Straight Auger	
	62855	T-102	Funnel Auger	-
	27642	T-125	Straight Retrieving Auger	
	62860	T-103	Sawtooth Cutter, 2 1/2" (65 mm)	98070
	62865	T-104	"H" Cutter, 2 1/2" (65 mm)	97800
	62870	T-105	Grease Cutter, 2 1/2" (65 mm)	97920
	62875	T-106	Grease Cutter, 3 1/2" (87 mm)	97925
	62915	T-109	Spiral Sawtooth Cutter, 1 3/4" (45 mm)	97930
	62920	T-110	Spiral Sawtooth Cutter, 2 1/4" (57 mm)	97935
	62925	T-111	Spiral Sawtooth Cutter, 3" (75 mm)	92890
	62930	T-112	4-Blade Cutter, 1 3/4" (45 mm)	97915
	62935	T-113	4-Blade Cutter, 3" (75 mm)	97910
	62940	T-114	Chain Knocker for 4" lines	97985
	98050	T-150	Sharktooth Cutter 3" (75 mm) and 4" (110 mm)	-
	98055	T-150-1	Sharktooth Cutter 3" (75 mm) Blade	98005- 3" (75mm)/ 98010- 3" (100mm)
	98060	T-150-2	Sharktooth Cutter 4" (110 mm) Blade	98010
	62880	T-107	Spade Cutter, 1 3/4" (45 mm)	92850
	54842	T-141	Knife Blade Cutter 1 1/2" (40 mm)	54847
	54852	T-142	Knife Blade Cutter 2 1/2" (65 mm)	97800

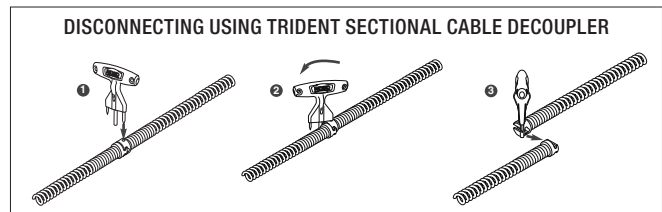

Sectional Machines

K-5208 SECTIONAL MACHINE

- Cleans 2"-8" diameter Drain Lines.
- The most powerful compact sectional on the market with a footprint like the K-60 – With a ¾-HP motor the K-5208 delivers power comparable to the K-1500. Designed to have a 71% smaller footprint and a 35% reduction in weight, the K-5208 delivers heavy duty power in a compact design.
- **Tool-Less Clutch Adjustment** – Improve your uptime and flexibility by seamlessly switching between 7/8" and 1-1/4" cables sizes without the use of a tool.
- **In Field Clutch Serviceability** – Easily change the clutch when a replacement is needed with our revolutionary in-field clutch service access panel.
- **Cord and Fluid Management** – The K-5208's cord management wraps neatly around the machine allowing you to quickly dump the cord so you can get to work quickly. The fluid management also contains mess on the job while improving the K-5208's bearing life. Simply remove the drain plug after the job is complete to dispose of the waste fluids.
- **Cable Carrier** – The Sectional Cable Carrier enables you to transport, load and unload cables in and out of the jobsite faster than before. Our innovative design reduces jobsite contamination by containing soiled cables.
- **Rear Guide Hose Lock** – New locking pin design allows you to easily connect the machine to ensure your guide hose stays in place.
- **Trident Sectional Cable Decoupler** – Ergonomically designed for ease of use, the heavy-duty Trident quickly and easily separates 5/8", 7/8" and 1-1/4" sectional cables.



SPECIFICATIONS

- Drain Capacity – 2" – 8"
- Cable Size – 7/8" & 1-1/4"
- Machine Weight – 54 lbs
- Operating Speed – 700 RPM
- Motor Output – 3/4 HP
- Carrier Capacity – (12) 5/8" x 7.5', (5) 7/8" x 15' OR (4) 1-1/4" x 15' Cables
- Trident Capacity – 5/8", 7/8", and 1-1/4" Sectional Cables

Machine Options

Catalog No.	Model No.	Description	Voltage		Weight	
			V	lb.	kg	
61688		Machine with guide hose	115	83	37.7	
61693	K-5208	Machine with guide hose, qty: 4 C-11 cables, sectional cable carrier, and toolbox (w/cutters) kit	115	223	101.2	
62378		Machine with guide hose, qty: 7 C-11 cables, qty: 2 A-8 wire baskets, and toolbox (w/cutters) kit	115	250	113.4	



Cable Carrier
Cat. #61708











Trident Sectional
Cable Decoupler
Cat. #61718



K-5208 Kit
Cat. #61693

Cables and Leaders

	Catalog No.	Model No.	Description	Weight		
				lb.	kg	
1 1/4" - 32 mm		62280	C-11	1 1/4" (32 mm) x 15' (4.6 m) Standard All-Purpose Wind. 3/8" (10 mm) Pitch. Good for 4" (110 mm) Traps, 3" (75 mm) - 8" (200 mm) Lines	16	7.3
		24226	C-11 PC	15' (4.6 m) Standard All-Purpose Wind 3/8" Pitch with Plastic Core, Good For 4" Traps	17 3/8	8.0
		62285	C-12	15' (4.6 m) Extra-Heavy-Duty Wind. 3/8" (10 mm) Pitch. Recommended For 4" (110 mm) - 10" (250 mm) Long Runs, No 4" (110 mm) Traps	19	8.6
		62295	C-14	15' (4.6) Heavy-Duty Wind. 1/2" (13 mm) Pitch. Recommended For 3" (75 mm) - 10" (250 mm) Lines Through Cleanout, No 4" (110 mm) Traps	16	6.8
		62300	C-15	15' (4.6) Extra-Flexible Wind. 1/2" (13 mm) Pitch. Recommended For 3" (75 mm) - 6" (150 mm) Lines Good for Traps	12	5.5
		63090	T-27	1 1/4" (32 mm) x 25" (63.5 cm) Leader	2 3/4	1.2
		62275	C-10	7/8" (22 mm) x 15' (4.6 m) All-Purpose Wind Requires A-368-X Jawset	9 1/2	4.3
7/8" - 22 mm		25036	C-10 PC	7/8" (22 mm) x 15' Cable with Inner Core (4.6 m) Requires A-368-X Jawset	10	4.5

Accessories

	Catalog No.	Model No.	Description	Weight	
				lb.	kg
	59205	A-1	Left-Hand RIDGID Drain Cleaning Mitt	1/2	0.2
	59295	A-2	Right-Hand RIDGID Drain Cleaning Mitt		
	59225	A-12	1/2" Cable Pin Key		
	61718	-	Trident Sectional Cable Decoupler	3/4	0.3
	61708	-	Sectional Cable Carrier	33	15
	61713	-	Sectional Cable Drum	15	6.8
	61723	-	Toolbox w/cutters	8	3.6
	59240	A-17	Manhole Guide Pipe	23	10.4
	59300	A-20	8-Foot (2.4 m) Front Guide Hose Assembly	25	11.4
	59320	A-369X	1 1/4" Jaw Assembly	3/4	0.3
	59325	A-368X	7/8" Jaw Assembly		
	59360	A-3	Tool Box	5	2.3
	59395	A-34-15	15-Foot (4.6 m) Rear Guide Hose	20	9.1
	59400	A-34-16	16-Foot (4.9 m) Rear Guide Hose	26 1/2	12.0
	59415	A-34-10	10-Foot (3.1 m) Rear Guide Hose	13 3/8	6.2
	59440	A-4	Trap Spoon (30", 76 cm)	1 3/4	0.8
	59470	A-8	Cable Carrier 60' (18 m) Capacity 1 1/4" (32 mm)	5 1/2	2.5
	59475	A-9	Cable Carrier 150-Foot (45.7) Capacity 1 1/4" (32 mm)	14	6.4
	62467	A-1HD	Heavy-Duty Left-Hand RIDGID Drain Cleaning Mitt	1/2	0.2
	62472	A-2HD	Heavy-Duty Right-Hand RIDGID Drain Cleaning Mitt		

Tools - Fits 1 1/4" Sectional Cables

	Catalog No.	Model No.	Description	Replac. Blade(s)
	59480	T-11	"H" Cutter, 2 1/2" (65 mm)	97800
	59485	T-12	"H" Cutter, 3 1/2" (89 mm)	97945
	61770	T-15A	Expanding Cutter, 4" - 6" (110-150 mm)	62970
	61790	T-4	Heavy-Duty Funnel Auger	-
	61800	T-2	Heavy-Duty Straight Auger	-
	61825	T-15B	Expanding Cutter, 6" - 8" (150-200 mm)	62980
	61970	T-13	Sawtooth Cutter, 2 1/2" (65 mm)	98070
	61975	T-14	Sawtooth Cutter, 3 1/2" (89 mm)	98075
	62840	T-1	Straight Auger	-
	62845	T-10	Grease Cutter, 4 1/2" (114 mm)	97865
	63105	T-3	Funnel Auger	-
	63190	T-5	A-3565 Key	-
	63195	T-6	Funnel Retrieving Auger Run Machine In Reverse	-
	63200	T-7	Hook Auger	-
	63205	T-8	Grease Cutter, 2 1/2" (65 mm)	97920
	63210	T-9	Grease Cutter, 3 1/2" (89 mm)	97925
	59625	T-21	Spiral Sawtooth Cutter, 2 1/2" (65 mm)	97970
	59765	T-24	4-Blade Cutter, 2 1/2" (65 mm)	97940
	59770	T-25	4-Blade Cutter, 3 1/2" (89 mm)	97975
	59775	T-26	4-Blade Cutter, 4 1/2" (114 mm)	97805
	59780	T-26A	4-Blade Cutter, 5 1/2" (140 mm)	97980
	61850	T-17	Spiral Bar Cutter, 6" (150 mm)	97955
	61855	T-18	Spiral Bar Cutter, 8" (200 mm)	97960
	61960	T-16	Spiral Bar Cutter, 4" (110 mm)	97855
	63075	T-22	Spiral Sawtooth Cutter, 3" (75 mm)	97970
	63085	T-23	Spiral Sawtooth Cutter, 4" (110 mm)	97850
	63110	T-31	Chain Knocker, For 3" - 4" Pipe (75-110 mm)	97985
	63115	T-32	Chain Knocker, For 6" Pipe (150 mm)	97990
	63120	T-33	Chain Knocker, For 8" Pipe (200 mm)	97995
	63145	T-38	Flue Brush, 1 1/2" (40 mm)	-
	63150	T-39	Flue Brush, 2" (50 mm)	-
	63155	T-40	Flue Brush, 2 1/2" (65 mm)	-
	63160	T-41	Flue Brush, 3" (76 mm)	-
	63165	T-42	Flue Brush, 3 1/2" (89 mm)	-
	63170	T-43	Flue Brush, 4" (110 mm)	-
	63175	T-44	Flue Brush, 4 1/2" (114 mm)	-
	63180	T-46	Flue Brush, 5 1/2" (140 mm)	-
	63185	T-47	Flue Brush, 6"	-
	63240	T-45	Flue Brush, 5" (127 mm)	-
	98030	T-50	Includes 3 Sizes: 3-4-5" (75-110-127 mm)	-
	98035	T-50-1	Sharktooth Cutter, 3" (75 mm)	98005
	98040	T-50-2	Sharktooth Cutter, 4" (110 mm)	98010
	98045	T-50-3	Sharktooth Cutter, 5" (127 mm)	98015

Sectional Machines



K-1500 SECTIONAL MACHINE

- 2" to 8" (50 mm to 200 mm) Drain and Sewer Lines
- The finest all-around sewer and drain cleaning machine. One man can easily clean the heaviest blockages – indoors or out. High-speed cleaning gets the job done faster and better.
- Wheels to the job site – sets up fast, cleans up fast.
- Low-profile "B" frame design will fit most crawl spaces. Loads and unloads from truck easily. Upright "A" frame features cable carrier storage during transport, ideal for in-house applications.
- Equipped to run, easy to handle, 15' (4.6 m) sections of 1 1/4" (32 mm) cable to clean 3" to 8" (32 m to 200 mm) lines to 200' (61 m).
- Easy clutch jaw change-out adapts K-1500 to run 15' (4.6) sections of 7/8" (22 mm) cable through 2" to 4" (50 to 100 mm) lines up to 175' (53 m).
- Equipped with 3/4 HP motor that spins cable at 710 RPM.



Model K-1500B (B-Frame)

Machine Options – A Frame

Catalog No.	Model No.	Description	Voltage			Weight		
			V	lb.	kg			
23692	K-1500A	Machine with A-1 Mitt, A-12 Pin Key, and Rear Guide Hose	115	135	61.3			
23702		Machine with A-1 Mitt, A-12 Pin Key, and A-34-12 Rear Guide Hose, Plus: Seven Sections 1 1/4" (32 mm) (C-14) Cable, Total 105 Feet, Two A-8 Cable Carriers, Nine-Piece 1 1/4" Tool Set	115					
23712		Machine with A-1 Mitt, A-12 Pin Key, and A-34-12 Rear Guide Hose, Plus: Seven Sections 1 1/4" (32 mm) (C-11) Cable, Total 105 Feet, Two A-8 Cable Carriers, Nine-Piece 1 1/4" Tool Set	115	256	116.1			
27592		Machine with A-1 Mitt, A-12 Pin Key, and A-34-12 Rear Guide Hose, Plus: Seven Sections 1 1/4" (32 mm) (C-11) Cable, Total 105 Feet, Two A-8 Cable Carriers, Nine-Piece 1 1/4" Tool Set	230					
27612		Machine with A-1 Mitt, A-12 Pin Key, and Rear Guide Hose	230	135	61.3			



Model K-1500 B W/C-11 shown above includes:









- K-1500 B Machine with A-1 RIDGID® Drain Cleaning Mitt, A-12 Pin Key and A-34-12 Rear Guide Hose
- Seven Sections of 1 1/4" (C-11) Cable, Total 105 Feet
- Two A-8 Cable Carriers
- *Nine-Piece Tool Set includes:
 - T-1 Straight Auger - 62840
 - T-3 Funnel Auger - 63105
 - T-6 Retrieving Auger - 63195
 - A-3516 Hex Key - 46190
 - T-13 Sawtooth Cutter - 61920
 - T-50-1 Sharktooth Cutter - 98035
 - A-2864 Hex Key -46030
 - T-8 Grease Cutter - 63205
 - A-3 Tool Box - 59360

*Sold Separately

Machine Options – B Frame

Catalog No.	Model No.	Description	Voltage			Weight		
			V	lb.	kg			
23697	K-1500B	Machine with A-1 Mitt, A-12 Pin Key, and A-34-12 Rear Guide Hose	115	135	61.3			
23707		Machine with A-1 Mitt, A-12 Pin Key, and A-34-12 Rear Guide Hose, Plus: Seven Sections 1 1/4" (32 m) (C-14) Cable Total 105' (32 m), Two A-8 Cable Carriers, Nine-Piece 1 1/4" Tool Set	115					
23717		Machine with A-1 Mitt, A-12 Pin Key, and A-34-12 Rear Guide Hose, Plus: Seven Sections 1 1/4" (32 m)(C-11) Cable, Total 105' (32 m), Two A-8 Cable Carriers, Nine-Piece 1 1/4" Tool Set	115	256	116.1			
27597		Machine with A-1 Mitt, A-12 Pin Key, and A-34-12 Rear Guide Hose, Plus: Seven Sections 1 1/4" (32 m) (C-11) Cable, Total 105' (32 m), Two A-8 Cable Carriers, Nine-Piece 1 1/4" Tool Set	230					
27617		Machine with A-1 Mitt, A-12 Pin Key, and A-34-12 Rear Guide Hose	230	135	61.3			
27637	K-1500B Special Kit	Machine with A-1 Mitt, A-12 Pin Key, and A-34-12 Rear Guide Hose, Plus: Seven Sections 1 1/4" (32 mm) (C-11) Cable, Total 105' (32 m), Two A-8 Cable Carriers, Nine-Piece 1 1/4" Tool Set	230	256	116.1			
33922		Machine with A-1 Mitt, A-12 Pin Key, A-34-12 Rear Guide Hose, four Sections 1 1/4" (32mm) (C11) Cable, Total 60' (18m), one A-8 Cable Carrier, T-3 funnel auger, T-50-1 shark tooth cutter and hex key.	230	210	95.0			

Cables and Leaders

	Catalog No.	Model No.	Description	Weight		
				lb.	kg	
1 1/4" - 32 mm		62280	C-11	1 1/4" (32 mm) x 15' (4.6 m) Standard All-Purpose Wind. 3/8" (10 mm) Pitch. Good for 4" (110 mm) Traps, 3" (75 mm) - 8" (200 mm) Lines	16	7.3
		24226	C-11 PC	15' (4.6 m) Standard All-Purpose Wind 3/8" Pitch with Plastic Core, Good For 4" Traps	17 5/8	8.0
		62285	C-12	15' (4.6 m) Extra-Heavy-Duty Wind. 3/8" (10 mm) Pitch. Recommended For 4" (110 mm) - 10" (250 mm) Long Runs, No 4" (110 mm) Traps	19	8.6
		62295	C-14	15' (4.6) Heavy-Duty Wind. 1/2" (13 mm) Pitch. Recommended For 3" (75 mm) - 10" (250 mm) Lines Through Cleanout, No 4" (110 mm) Traps	16	6.8
		62300	C-15	15' (4.6) Extra-Flexible Wind. 1/2" (13 mm) Pitch. Recommended For 3" (75 mm) - 6" (150 mm) Lines Good for Traps	12	5.5
		63090	T-27	1 1/4" (32 mm) x 25" (63.5 cm) Leader	2 3/4	1.2
		62275	C-10	7/8" (22 mm) x 15' (4.6 m) All-Purpose Wind Requires A-368-X Jawset	9 1/2	4.3
7/8" - 22 mm		25036	C-10 PC	7/8" (22 mm) x 15' Cable with Inner Core (4.6 m) Requires A-368-X Jawset	10	4.5

Accessories

	Catalog No.	Model No.	Description	Weight	
				lb.	kg
	59205	A-1	Left-Hand RIDGID Drain Cleaning Mitt	1/2	0.2
	59295	A-2	Right-Hand RIDGID Drain Cleaning Mitt		
	59225	A-12	1/2" Cable Pin Key		
	61718	-	Trident Sectional Cable Decoupler	3/4	0.3
	61708	-	Sectional Cable Carrier	33	15
	61713	-	Sectional Cable Drum	15	6.8
	59240	A-17	Manhole Guide Pipe	23	10.4
	59300	A-20	8-Foot (2.4 m) Front Guide Hose Assembly	25	11.4
	59320	A-369X	1 1/4" Jaw Assembly	3/4	0.3
	59325	A-368X	7/8" Jaw Assembly		
	59360	A-3	Tool Box	5	2.3
	59395	A-34-15	15-Foot (4.6 m) Rear Guide Hose	20	9.1
	59400	A-34-16	16-Foot (4.9 m) Rear Guide Hose	26	12.0
	59415	A-34-10	10-Foot (3.1 m) Rear Guide Hose	13 3/8	6.2
	59440	A-4	Trap Spoon (30", 76 cm)	1 3/4	0.8
	59470	A-8	Cable Carrier 60' (18 m) Capacity 1 1/4" (32 mm)	5 1/2	2.5
	59475	A-9	Cable Carrier 150-Foot (45.7) Capacity 1 1/4" (32 mm)	14	6.4
	62467	A-1HD	Heavy-Duty Left-Hand RIDGID Drain Cleaning Mitt	1/2	0.2
	62472	A-2HD	Heavy-Duty Right-Hand RIDGID Drain Cleaning Mitt		

Tools - Fits 1 1/4" Sectional Cables

	Catalog No.	Model No.	Description	Replac. Blade(s)
	59480	T-11	"H" Cutter, 2 1/2" (65 mm)	97800
	59485	T-12	"H" Cutter, 3 1/2" (89 mm)	97945
	61770	T-15A	Expanding Cutter, 4" - 6" (110-150 mm)	62970
	61790	T-4	Heavy-Duty Funnel Auger	-
	61800	T-2	Heavy-Duty Straight Auger	-
	61825	T-15B	Expanding Cutter, 6" - 8" (150-200 mm)	62980
	61970	T-13	Sawtooth Cutter, 2 1/2" (65 mm)	98070
	61975	T-14	Sawtooth Cutter, 3 1/2" (89 mm)	98075
	62840	T-1	Straight Auger	-
	62845	T-10	Grease Cutter, 4 1/2" (114 mm)	97865
	63105	T-3	Funnel Auger	-
	63190	T-5	A-3565 Key	-
	63195	T-6	Funnel Retrieving Auger Run Machine In Reverse	-
	63200	T-7	Hook Auger	-
	63205	T-8	Grease Cutter, 2 1/2" (65 mm)	97920
	63210	T-9	Grease Cutter, 3 1/2" (89 mm)	97925
	59625	T-21	Spiral Sawtooth Cutter, 2 1/2" (65 mm)	97970
	59765	T-24	4-Blade Cutter, 2 1/2" (65 mm)	97940
	59770	T-25	4-Blade Cutter, 3 1/2" (89 mm)	97975
	59775	T-26	4-Blade Cutter, 4 1/2" (114 mm)	97805
	59780	T-26A	4-Blade Cutter, 5 1/2" (140 mm)	97980
	61850	T-17	Spiral Bar Cutter, 6" (150 mm)	97955
	61855	T-18	Spiral Bar Cutter, 8" (200 mm)	97960
	61960	T-16	Spiral Bar Cutter, 4" (110 mm)	97855
	63075	T-22	Spiral Sawtooth Cutter, 3" (75 mm)	97970
	63085	T-23	Spiral Sawtooth Cutter, 4" (110 mm)	97850
	63110	T-31	Chain Knocker, For 3" - 4" Pipe (75-110 mm)	97985
	63115	T-32	Chain Knocker, For 6" Pipe (150 mm)	97990
	63120	T-33	Chain Knocker, For 8" Pipe (200 mm)	97995
	63145	T-38	Flue Brush, 1 1/2" (40 mm)	-
	63150	T-39	Flue Brush, 2" (50 mm)	-
	63155	T-40	Flue Brush, 2 1/2" (65 mm)	-
	63160	T-41	Flue Brush, 3" (76 mm)	-
	63165	T-42	Flue Brush, 3 1/2" (89 mm)	-
	63170	T-43	Flue Brush, 4" (110 mm)	-
	63175	T-44	Flue Brush, 4 1/2" (114 mm)	-
	63180	T-46	Flue Brush, 5 1/2" (140 mm)	-
	63185	T-47	Flue Brush, 6"	-
	63240	T-45	Flue Brush, 5" (127 mm)	-
	98030	T-50	Includes 3 Sizes: 3-4-5" (75-110-127 mm)	-
	98035	T-50-1	Sharktooth Cutter, 3" (75 mm)	98005
	98040	T-50-2	Sharktooth Cutter, 4" (110 mm)	98010
	98045	T-50-3	Sharktooth Cutter, 5" (127 mm)	98015

Sectional Machines



K-1500SP SECTIONAL MACHINE

- 2" to 10" (50 mm to 250 mm) Drain and Sewer Lines.
- The finest all-around sewer and drain cleaning machine. One man can easily clean the heaviest blockages – indoors or out. High-speed cleaning gets the job done faster and better.
- Unique, easy-to-use, instant-acting cable clutch maximizes operator control.
- Equipped with full 1 HP motor that spins cable at 600 RPM.
- Wheels to the job site – sets up fast, cleans up fast.
- Equipped to run, easy to handle, 15' (4.6 m) sections of 1 1/4" (32 mm) cable to clean 3" (75 mm) to 10" (250 mm) lines to 300' (91 m).
- Easy clutch jaw change-out adapts K-1500 to run 15' (4.6 m) sections of 7/8" (22 mm) cable through 2" (50 mm) to 4" (110 mm) lines up to 175' (53 m).
- 10" solid ball bearing wheels.
- Low profile frame design will fit most crawl spaces.
- Includes A-1 RIDGID® drain cleaning mitt and operators manual.

Machine Options – B Frame

Catalog No.	Model No.	Description	Voltage			Weight		
			V	lb	kg			
43507	K-1500SP	Machine with A-1 Operator's Mitt and A-12 Pin Key, Plus: A-34-12 Rear Guide Hose	115	141	64.0			
46907		Machine with A-1 Operator's Mitt and A-12 Pin Key, Plus: A-34-12 Rear Guide Hose, A-34-12 Rear Guide Hose, 150' (45.7m), Ten Sections of C-11, 1 1/4" (32 mm) Cable, Three A-8 Cable Carriers, A-3 Tool Box, Eight-Piece 1 1/4" (32 mm) Tool Package	115	317	144.0			
91027	K-1500SPB	Machine with A-1 RIDGID Drain Cleaning Mitt and A-12 Pin Key Plus: A-34-12 Rear Guide Hose - C-14 Three Carrier Cable Combination Kit	115	297	135.0			
43512	K-1500SP-B	240V-50Hz Machine with A-1 Operator's Mitt and A-12 Pin Key, Plus: A-34-12 Rear Guide Hose	240	141	64.0			

Model K-1500SP with C-11 shown below

- K-1500SP w/C-11 includes:
K-1500SP Machine with A-1 RIDGID Drain Cleaning Mitt and A-12 Pin Key
- A-34-12 Rear Guide Hose
- 150 Feet, Ten Sections of C-11, 1 1/4" Cable
- Three A-8 Cable Carriers
- Nine-Piece 1 1/4" Tool Package, includes:
 - T-1 Straight Auger
 - T-3 Funnel Auger
 - T-6 Retrieving Auger
 - T-8 2 1/2" Grease Cutter
 - T-13 2 1/2" Sawtooth Cutter
 - T-50 Sharktooth Cutter with 3", 4" and 5" Blades
 - A-2864 Hex Key (3/16")
 - A-3 Tool Box
 - A-3516 Hex Key (1/4")

Machine Options - A Frame

Catalog No.	Model No.	Description	Voltage			Weight		
			V	lb	kg			
46837	K-1500SPA	Machine with A-1 Operator's Mitt and A-12 Pin Key, Plus: A-34-12 Rear Guide Hose	115	150	68.0			
46902		Machine with A-1 Operator's Mitt and A-12 Pin Key, Plus: A-34-12 Rear Guide Hose, A-34-12 Rear Guide Hose, 150' (45.7), Ten Sections of C-11, 1 1/4" (32 mm) Cable, Three A-8 Cable Carriers, A-3 Tool Box, Eight-Piece 1 1/4" (32 mm) Tool Package	115	326	148.0			
91032		Machine with A-1 Operator's Mitt and A-12 Pin Key, Plus: A-34-12 Rear Guide Hose & C-14 Three Carrier Cable Combination Kit	115	317	144.0			
45317	K-1500SP-A	Machine with A-1 RIDGID Drain Cleaning Mitt, A-12 Pin Key, and A-34-12 Rear Guide Hose, Plus SE Tool Kit (see below).	240	254	120.0			



Model K-1500SP with C-11 shown above.

Cables and Leaders

	Catalog No.	Model No.	Description	Weight	
				lb	kg
	24226	C-11 PC	15' (4,6 m) Standard All-Purpose Wind $\frac{3}{8}$ " Pitch with Plastic Core. Good For 4" Traps	17 $\frac{3}{5}$	8.0
	25036	C-10 PC	$\frac{7}{8}$ " (22 mm) x 15' Cable with Inner Core (4,6 m) Requires A-368-X Jawset	10	4.5
	62275	C-10	$\frac{7}{8}$ " (22 mm) x 15' (4,6 m) All-Purpose Wind Requires A-368-X Jawset	9 $\frac{1}{2}$	4.3
	62280	C-11	1 $\frac{1}{4}$ " (32 mm) x 15' (4,6 m) Standard All-Purpose Wind. $\frac{3}{8}$ " (10 mm) Pitch. Good for 4" (110 mm) Traps, 3" (75 mm) - 8" (200 mm) Lines	16	7.3
	62285	C-12	15' (4,6 m) Extra-Heavy-Duty Wind. $\frac{3}{8}$ " (10 mm) Pitch. Recommended For 4" (110 mm) - 10" (250 mm) Long Runs, No 4" (110 mm) Traps	19	8.6
	62295	C-14	15' (4,6) Heavy-Duty Wind. $\frac{1}{2}$ " (13 mm) Pitch. Recommended For 3" (75 mm) - 10" (250 mm) Lines Through Cleanout, No 4" (110 mm) Traps	16	6.8
	62300	C-15	15' (4,6) Extra-Flexible Wind. $\frac{1}{2}$ " (13 mm) Pitch. Recommended For 3" (75 mm) - 6" (150 mm) Lines Good for Traps	12	5.5
	63090	T-27	1 $\frac{1}{4}$ " (32 mm) x 25' (63,5 cm) Leader	2 $\frac{3}{4}$	1.2

Accessories

	Catalog No.	Model No.	Description	Weight	
				lb	kg
	59470	A-8	Cable Carrier 60' (18 m) Capacity 1 $\frac{1}{4}$ " (32 mm)	5 $\frac{1}{2}$	2.5
	59475	A-9	Cable Carrier 150-Foot (45,7) Capacity 1 $\frac{1}{4}$ " (32 mm)	14	6.4
	59395	A-34-12	12-Foot (3,7 m) Rear Guide Hose	20	9.1
	59415	A-34-10	10-Foot (3,1 m) Rear Guide Hose	13 $\frac{3}{8}$	6.2
	59400	A-34-16	16-Foot (4,9 m) Rear Guide Hose	26 $\frac{1}{2}$	12.0
	59300	A-20	8-Foot (2,4 m) Front Guide Hose Assembly	25	11.4
	59205	A-1	Left-Hand RIDGID Drain Cleaning Mitt	1 $\frac{1}{2}$	0.2
	59295	A-2	Right-Hand RIDGID Drain Cleaning Mitt		
	62467	A-1HD	Heavy-Duty Left-Hand RIDGID Drain Cleaning Mitt	1 $\frac{1}{2}$	0.2
	62472	A-2HD	Heavy-Duty Right-Hand RIDGID Drain Cleaning Mitt		
	59360	A-3	Tool Box	5	2.3
	59225	A-12	$\frac{1}{2}$ " Cable Pin Key	1 $\frac{1}{2}$	0.2
	59440	A-4	Trap Spoon (30", 76 cm)	1 $\frac{3}{4}$	0.8
	59240	A-17	Manhole Guide Pipe	23	10.4
	59320	A-369X	1 $\frac{1}{4}$ " Jaw Assembly	3 $\frac{1}{4}$	0.3
	59325	A-368X	$\frac{7}{8}$ " Jaw Assembly		
	61708	-	Sectional Cable Carrier	33	15
	61713	-	Sectional Cable Drum	15	6.8
	61718	-	Trident Sectional Cable Decoupler	3 $\frac{1}{4}$	0.3

Tools

	Catalog No.	Model No.	Description	Replac. Blade(s)	
				lb	kg
	59480	T-11	"H" Cutter, 2 $\frac{1}{2}$ " (65 mm)	97800	
	59485	T-12	"H" Cutter, 3 $\frac{1}{2}$ " (89 mm)	97945	
	59625	T-21	Spiral Sawtooth Cutter, 2 $\frac{1}{2}$ " (65 mm)	97970	
	59765	T-24	4-Blade Cutter, 2 $\frac{1}{2}$ " (65 mm)	97940	
	59770	T-25	4-Blade Cutter, 3 $\frac{1}{2}$ " (89 mm)	97975	
	59775	T-26	4-Blade Cutter, 4 $\frac{1}{2}$ " (114 mm)	97805	
	59780	T-26A	4-Blade Cutter, 5 $\frac{1}{2}$ " (140 mm)	97980	
	61770	T-15A	Expanding Cutter, 4" - 6" (110-150 mm)	62970	
	61790	T-4	Heavy-Duty Funnel Auger	-	
	61800	T-2	Heavy-Duty Straight Auger	-	
	61825	T-15B	Expanding Cutter, 6" - 8" (150-200 mm)	62980	
	61850	T-17	Spiral Bar Cutter, 6" (150 mm)	97955	
	61855	T-18	Spiral Bar Cutter, 8" (200 mm)	97960	
	61960	T-16	Spiral Bar Cutter, 4" (110 mm)	97855	
	61970	T-13	Sawtooth Cutter, 2 $\frac{1}{2}$ " (65 mm)	98070	
	62840	T-1	Straight Auger	-	
	62845	T-10	Grease Cutter, 4 $\frac{1}{2}$ " (114 mm)	97865	
	63075	T-22	Spiral Sawtooth Cutter, 3" (75 mm)	97970	
	63085	T-23	Spiral Sawtooth Cutter, 4" (110 mm)	97850	
	63105	T-3	Funnel Auger	-	
	63110	T-31	Chain Knocker, For 3" - 4" Pipe (75-110 mm)	97985	
	63115	T-32	Chain Knocker, For 6" Pipe (150 mm)	97990	
	63120	T-33	Chain Knocker, For 8" Pipe (200 mm)	97995	
	63145	T-38	Flue Brush, 1 $\frac{1}{2}$ " (40 mm)	-	
	63150	T-39	Flue Brush, 2" (50 mm)		
	63155	T-40	Flue Brush, 2 $\frac{1}{2}$ " (65 mm)		
	63160	T-41	Flue Brush, 3" (76 mm)		
	63165	T-42	Flue Brush, 3 $\frac{1}{2}$ " (89 mm)		
	63170	T-43	Flue Brush, 4" (110 mm)		
	63175	T-44	Flue Brush, 4 $\frac{1}{2}$ " (114 mm)		
	63180	T-46	Flue Brush, 5 $\frac{1}{2}$ " (140 mm)		
	63185	T-47	Flue Brush, 6"		
	63190	T-5	A-3565 Key		
	63195	T-6	Funnel Retrieving Auger Run Machine In Reverse	-	
	63200	T-7	Hook Auger	-	
	63205	T-8	Grease Cutter, 2 $\frac{1}{2}$ " (65 mm)	97920	
	63210	T-9	Grease Cutter, 3 $\frac{1}{2}$ " (89 mm)	97925	
	63240	T-45	Flue Brush, 5" (127 mm)	-	
	98030	T-50	Includes 3 Sizes: 3-4-5" (75-110-127 mm)	-	
	98035	T-50-1	Sharktooth Cutter, 3" (75 mm)	98005	
	98040	T-50-2	Sharktooth Cutter, 4" (110 mm)	98010	
	98045	T-50-3	Sharktooth Cutter, 5" (127 mm)	98015	

C-14 Heavy-Duty Accessories

	Catalog No.	Model No.	Description	Weight	
				lb	kg
	48457	-	C-14 Three-Carrier Cable Combination Kit Includes: 150' C-14 Cable, Ten Sections 1 $\frac{1}{4}$ ", Three Cable Carriers, A-3 Toolbox and A-12 Pin Key, T-2 HD Straight Auger, T-4 HD Funnel Auger; T-6 Funnel Retrieving Auger; T-8 Spade Cutter; T-13 Saw Tooth Cutters; T-50 Sharktooth	160	72.6

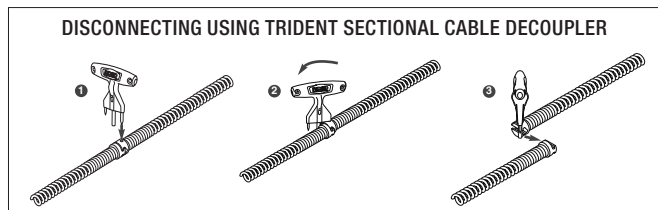

Sectional Machines



K-1500G SECTIONAL MACHINE

- 2" to 10" (50 to 250 mm) Drain/Sewer Lines
- A gasoline engine makes the Model K-1500G well-suited for cleaning lines in remote locations where electrical power is unavailable. Cuts through roots fast.
- Unique, easy-to-use, instant-acting cable clutch maximizes operator control. Pull down on the handle and the cable spins at 600 RPM. Release handle, cable stops instantly.
- Comes equipped to use 1 1/4" (32 mm) cable to clean 3" (75 mm) to 10" (250 mm) lines through 300' (92 m).
- 6 HP gasoline engine drives cable via four-speed transmission. Allows the operator to vary the cable spinning speed to fit the application. Forward speeds of 333, 425 and 500 RPM, and a reverse speed of 250 RPM.
- Low-profile, four-wheel cart easily rolls to the job. Guards against machine upset and possible fuel spillage.
- Includes A-1 RIDGID® drain cleaning mitt and operator's manual.

MACHINE DIMENSIONS

- Width Wheel to Wheel – 26" (66 cm)
- Length Including Kickstand – 28" (71 cm)
- Ground to Top of Handle – 38" (97 cm)
- Back of Handle to Front – 49" (124 cm)
- Ground to Top of Housing Shell – 27" (60 cm)

Catalog No.	Model No.	Description	Weight	
			lb	kg
44587	K-1500G	Machine Only with A-1 RIDGID Drain Cleaning Mitt, A-12 Coupling Pin Key and A-34-10 Rear Guide Hose, A-369-X 1 1/4" (32 mm) Jaw Set	190	86.4
48462	K-1500G with C-14	Machine with Standard Equipment, includes: – Ten Sections Of C-14 Cable, Total 150' (45.7 m) – Three A-8 Cable Carriers – A-1 Left-Hand RIDGID Drain Cleaning Mitt – A-12 Coupling Pin Key – A-34-12 Rear Guide Hose – A-2864 Hex Key – A-3516 Hex Key – A-3 Tool Box – T-2 Heavy-Duty Straight Auger – T-4 Heavy-Duty Funnel Auger – T-6 Retrieving Auger – T-8 Grease Cutter – T-13 Sawtooth Cutter – T-50 Sharktooth Cutter	350	159.0

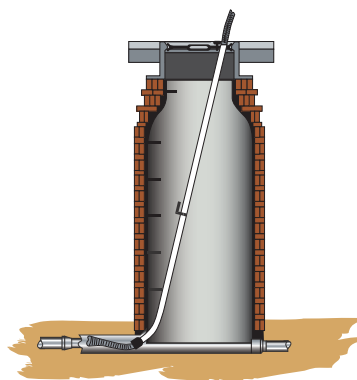







A-17 Manhole Guide Pipe

Adjusts 7' to 12', supports cables, locks into place quickly.



Model K-1500G with C-14 shown above.

Cables and Leaders







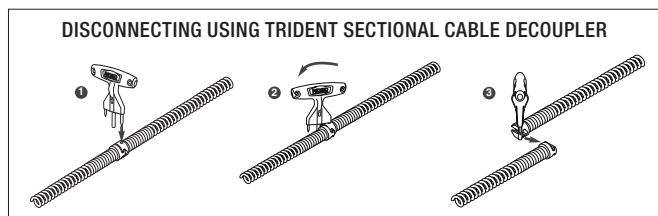





















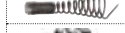











	Catalog No.	Model No.	Description	Weight	
				lb	kg
	25036	C-10 PC	7/8" (22 mm) x 15' Cable with Inner Core (4,6 m) Requires A-368-X Jawset	10	4.5
	62275	C-10	7/8" (22 mm) x 15' (4,6 m) All-Purpose Wind Requires A-368-X Jawset	9 1/2	4.3
	62280	C-11	1 1/4" (32 mm) x 15' (4,6 m) Standard All-Purpose Wind. 3/8" (10 mm) Pitch. Good for 4" (110 mm) Traps, 3" (75 mm) - 8" (200 mm) Lines	16	7.3
	62285	C-12	15' (4,6 m) Extra-Heavy-Duty Wind. 3/8" (10 mm) Pitch. Recommended For 4" (110 mm) - 10" (250 mm) Long Runs, No 4" (110 mm) Traps	19	8.6
	62295	C-14	15' (4,6) Heavy-Duty Wind. 1/2" (13 mm) Pitch. Recommended For 3" (75 mm) - 10" (250 mm) Lines Through Cleanout, No 4" (110 mm) Traps	16	6.8
	62300	C-15	15' (4,6) Extra-Flexible Wind. 1/2" (13 mm) Pitch. Recommended For 3" (75 mm) - 6" (150 mm) Lines Good for Traps	12	5.5
	63090	T-27	1 1/4" (32 mm) x 25' (63,5 cm) Leader	2 3/4	1.2

Accessories

	Catalog No.	Model No.	Description	Weight	
				lb	kg
	59205	A-1	Left-Hand RIDGID Drain Cleaning Mitt	1/2	0.2
	59225	A-12	1/2" Cable Pin Key		
	59240	A-17	Manhole Guide Pipe	23	10.4
	59295	A-2	Right-Hand RIDGID Drain Cleaning Mitt	1/2	0.2
	59300	A-20	8-Foot (2,4 m) Front Guide Hose Assembly	25	11.4
	59320	A-369X	1 1/4" Jaw Assembly	3/4	0.3
	59360	A-3	Tool Box	5	2.3
	59395	A-34-12	12-Foot (3,7 m) Rear Guide Hose	20	9.1
	59415	A-34-10	10-Foot (3,1 m) Rear Guide Hose	13 3/8	6.2
	59440	A-4	Trap Spoon (30", 76 cm)	1 3/4	0.8
	59470	A-8	Cable Carrier 60' (18 m) Capacity 1 1/4" (32 mm)	5 1/2	2.5
	59475	A-9	Cable Carrier 150-Foot (45,7) Capacity 1 1/4" (32 mm)	14	6.4
	59400	A-34-16	16-Foot (4,9 m) Rear Guide Hose	26 1/2	12.0
	61708	-	Sectional Cable Carrier	33	15
	61713	-	Sectional Cable Drum	15	6.8
	61718	-	Trident Sectional Cable Decoupler	3/4	0.3



Tools

	Catalog No.	Model No.	Description	Replac. Blade(s)
	59485	T-12	"H" Cutter, 3 1/2" (89 mm)	97945
	59625	T-21	Spiral Sawtooth Cutter, 2 1/2" (65 mm)	97970
	59765	T-24	4-Blade Cutter, 2 1/2" (65 mm)	97940
	59770	T-25	4-Blade Cutter, 3 1/2" (89 mm)	97975
	59775	T-26	4-Blade Cutter, 4 1/2" (114 mm)	97805
	59780	T-26A	4-Blade Cutter, 5 1/2" (140 mm)	97980
	61770	T-15A	Expanding Cutter, 4" - 6" (110-150 mm)	62970
	61790	T-4	Heavy-Duty Funnel Auger	-
	61800	T-2	Heavy-Duty Straight Auger	-
	61825	T-15B	Expanding Cutter, 6" - 8" (150-200 mm)	62980
	61850	T-17	Spiral Bar Cutter, 6" (150 mm)	97955
	61855	T-18	Spiral Bar Cutter, 8" (200 mm)	97960
	61960	T-16	Spiral Bar Cutter, 4" (110 mm)	97855
	61970	T-13	Sawtooth Cutter, 2 1/2" (65 mm)	98070
	61975	T-14	Sawtooth Cutter, 3 1/2" (89 mm)	98075
	62840	T-1	Straight Auger	-
	62845	T-10	Grease Cutter, 4 1/2" (114 mm)	97865
	63075	T-22	Spiral Sawtooth Cutter, 3" (75 mm)	97970
	63085	T-23	Spiral Sawtooth Cutter, 4" (110 mm)	97850
	63105	T-3	Funnel Auger	-
	63110	T-31	Chain Knocker, For 3" - 4" Pipe (75-110 mm)	97985
	63115	T-32	Chain Knocker, For 6" Pipe (150 mm)	97990
	63120	T-33	Chain Knocker, For 8" Pipe (200 mm)	97995
	63145	T-38	Flue Brush, 1 1/2" (40 mm)	-
	63150	T-39	Flue Brush, 2" (50 mm)	-
	63155	T-40	Flue Brush, 2 1/2" (65 mm)	-
	63160	T-41	Flue Brush, 3" (76 mm)	-
	63165	T-42	Flue Brush, 3 1/2" (89 mm)	-
	63170	T-43	Flue Brush, 4" (110 mm)	-
	63175	T-44	Flue Brush, 4 1/2" (114 mm)	-
	63180	T-46	Flue Brush, 5 1/2" (140 mm)	-
	63190	T-5	A-3565 Key	-
	63195	T-6	Funnel Retrieving Auger Run Machine In Reverse	-
	63200	T-7	Hook Auger	-
	63205	T-8	Grease Cutter, 2 1/2" (65 mm)	97920
	63210	T-9	Grease Cutter, 3 1/2" (89 mm)	97925
	63240	T-45	Flue Brush, 5" (127 mm)	-
	98030	T-50	Includes 3 Sizes: 3-4-5" (75-110-127 mm)	-
	98035	T-50-1	Sharktooth Cutter, 3" (75 mm)	98005
	98040	T-50-2	Sharktooth Cutter, 4" (110 mm)	98010
	98045	T-50-3	Sharktooth Cutter, 5" (127 mm)	98015

Rodder Machines





K-1000 RODDER MACHINE













- 8" to 24" (200 to 610mm) Drain/Sewer Lines.
- A rugged, compact machine suited for straight main line work in municipalities, universities, institutions and industry. Drives sectional sewer rods through long, straight runs of larger diameter pipe – up to 500 feet (150 m).
- Equipped with a 6 HP gasoline engine and forward/reverse transmission. Rod rotates at 133 RPM in forward and reverse at full throttle.
- Spring-loaded throttle control is hand operated. Varies rod speed within range. Returns engine speed to idle and disengages clutch when operator releases throttle.
- Adjustable torque limiter minimizes kinking of rods and excessive torque through transmission system.
- Large 10" (250 mm) wheels on frame for optimal transport.
- Includes A-1 RIDGID® drain cleaning mitt and operator's manual.

Catalog No.	Model No.	Description	Weight	
			lb	kg
59175	K-1000	Rodder Machine, includes: – B-3542 Rod Driver – A-2704 Tool Driver – A-3567 Drive Pin – R-0 Rod Turner – A-4558 Torque Adapter – A-12 Coupling Pin Key – A-1 Left-Hand RIDGID Drain Cleaning Mitt – A-2 Right-Hand RIDGID Drain Cleaning Mitt	160	75.0
84295		Rodder Machine, same as above, plus: – 20 Sections of A-2475, 5/16" (8 mm) Rod, Total of 100' (30 m) – T-300 Spear Head Cutter – T-317 Auger – T-326 Pick-Up Tool	210	95.0

Rods

	Catalog No.	Model No.	Description	Weight	
				lb.	kg
	60355	A-2474	3' (0,9 m) Solid Sectional Rod, Includes: R-1 Male and R-2 Female Couplings	1 ¼	0.6
	60360	A-2475	5' (1,5 m) Solid Sectional Rod, Includes: R-1 Male and R-2 Female Couplings	1 ¾	0.8
	60365	A-2476	10' (3,0 m) Solid Sectional Rod, Includes: R-1 Male and R-2 Female Couplings	3	1.4

Accessories

	Catalog No.	Model No.	Description	Weight	
				lb.	kg
	59835	K-10	Complete Set of Quick- Connect Rod Couplings: One Each R-1 and R-2	¾	0.2
	59560	R-1	Male Rod Coupling	¼	0.1
	59555	R-2	Female Rod Coupling	¼	
	61875	R-7	Male Tool Coupling, connects Tool Adapter to Rodding Tool	½	0.2
	61885	R-8	Female Tool Coupling, connects Tool to Tool Adapter	½	0.2
	60700	A-2704	Tool Adapter, includes R-2 and R-7 Couplings	2 ¼	1.0
	62170	B-3542	B-3542 Rod Holder	3 ¾	1.5
	62815	R-0	Rod Turner, used to manually turn Rods in short runs	3 ¼	
	59205	A-1	Left-Hand RIDGID Drain Cleaning Mitt	½	0.2
	59295	A-2	Right-Hand RIDGID Drain Cleaning Mitt		
	59360	A-3	Tool Box	5	2.3
	59225	A-12	½" Cable Pin Key	½	0.2

RODS, RODDING TOOLS AND ACCESSORIES

- RIDGID K-10 quick-connect couplings make rodding jobs easier than ordinary threaded couplings:
 - To connect rods, align and snap them together for a solid connection (Fig. 1 and 2).
 - To disconnect, insert the pin key and slide the couplings apart (Fig. 3).





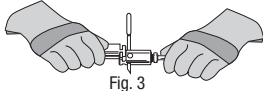





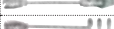

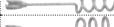
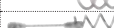



- To disconnect, insert the pin key and slide the couplings apart (Fig. 3).

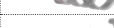

- One coupling pin key replaces assembly tool and wrench required to connect ordinary threaded couplings. Easy-to-add rods or tools. No bulky reels.
- Convert existing tools and rods to the RIDGID quick-connect system
 - One pair of R1 and R2 couplings substitute for one threaded coupling.
 - Standard left-hand and-right hand rod nuts fasten R1 and R2 couplings to existing rods.
 - R-8 couplings adapt each rod tool to quick-connect system.
 - A-2704 adapts rod couplings to larger-size tool couplings.

Tools

	Catalog No.	Model No.	Description	Weight	
				lb.	kg
	62045	T-300	Spear Head	1 7/8	0.8
	62050	T-301	Round Stock Corkscrew, 1 ½" (40 mm)	1 ¼	0.6
	62055	T-302	Round Stock Corkscrew, 2" (50 mm)	1 ½	0.7
	62060	T-303	Round Stock Corkscrew, 2 ½" (65 mm)	1 ¾	0.8
	62065	T-304	Round Stock Corkscrew, 3" (75 mm)		
	62075	T-306	Double Corkscrew, 3" (75 mm)	2 ¼	1.0
	62080	T-307	Double Corkscrew, 4" (110 mm)	2 ½	1.1
	62095	T-310	Square Stock Corkscrew, 4" (110 mm)		
	62105	T-312	Square Stock Corkscrew, 6" (150 mm)	3 ¾	1.7
	62370	T-313	Square Stock Corkscrew, 8" (200 mm)	6 ½	3.0
	62110	T-316	Auger, 3" (75 mm)	3	1.4
	62115	T-317	Auger, 4" (110 mm)	3 ½	1.5
	62125	T-319	Auger, 6" (150 mm)	5	2.3
	62385	T-320	Auger, 8" (200 mm)	8 ½	3.9
	62390	T-321	Auger, 10" (250 mm)	9 ½	4.3
	62140	T-326	Pick-Up Tool	1	0.5

The following Heavy-Duty Cable tools are also recommended for use with the rod:

	Catalog No.	Model No.	Description	Weight	
				lb.	kg
	61800	T-2	Heavy-Duty Straight Auger	1	0.5
	61790	T-4	Heavy-Duty Funnel Auger	1	0.5
	63200	T-7	Hook Auger	1 ½	0.7
	61960	T-16	Spiral Bar Cutter, 4" (110 mm)	1	0.5
	61850	T-17	Spiral Bar Cutter, 6" (150 mm)	2	0.9
	61855	T-18	Spiral Bar Cutter, 8" (200 mm)	2 ½	1.1
	63085	T-23	Spiral Sawtooth Cutter, 4" (110 mm)	½	0.2
	59765	T-24	4-Blade Cutter, 2 ½" (65 mm)	½	0.2
	59770	T-25	4-Blade Cutter, 3 ½" (89 mm)	¾	0.3
	59775	T-26	4-Blade Cutter, 4 ½" (114 mm)	1 ¼	0.6
	59780	T-26A	4-Blade Cutter, 5 ½" (140 mm)	1 ½	0.7

