

882MSR

magnetic quick release bit holder for drivers

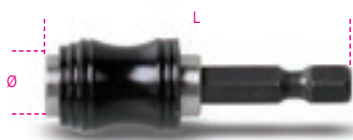

ISO 1173 E 6,3

L mm	○	●	Ø mm		
50	1/4	1/4	11	5	008820205
75	1/4	1/4	11	5	008820207

882P

magnetic bit holder extension bar



L mm	●	○	Ø mm		
80	1/4	1/4	10	5	008820080

892

adaptors for drivers



	■	●	L mm		
892/0	1/4	1/4	25	5	008920000
* 892/1	1/4	5,5	50	5	008920001
* 892/2	3/8	5,5	50	5	008920002
° 892/3	1/4	1/4	50	5	008920003
° 892/4	3/8	1/4	50	5	008920004
892/5	1/4	5/16	75	5	008920005
892/6	3/8	5/16	75	5	008920006
892/7	1/2	1/4	75	5	008920007

* ISO 1173 A 5,5
° ISO 1173 C 6,3



895

socket holder for bits
item 861 - 862 - 866



DIN 7427

	○	□	L mm	Ø mm		
895/1	1/4	1/4	25,4	12	5	008950000
895/3	1/4	3/8	29	16,8	5	008950001
895/4	5/16	3/8	29	16,8	5	008950002
895/5	1/4	1/2	38	22	5	008950005
895/6	5/16	1/2	38	22	5	008950003

897

flexible bit holder with handle



L mm	L1 mm		
280	154	2	008970010

897L

flexible bit holder with handle, long model



L mm	L1 mm		
500	380	2	008970015

RATCHETS 9XX/55

Compact head



Operates in small spaces, at an angle of no more than 5°, thanks to the 72-tooth ring gear



Prevents slipping or releasing under tension

- Pressing of hand on ratchet head does not cause reversal and always allows free lever return
- One-handed reversal
- Outstanding mechanical characteristics



Reduced work load, 17 teeth in contact with gear at all times

900

hexagon hand sockets



UNI/ISO 2725 DIN 3124

mm	Ø	L	Ø1	
3,2	6,6	25	11,8	10 009000032
4	6,8	25	11,8	10 009000040
4,5	7,4	25	11,8	10 009000045
5	8,0	25	11,8	10 009000050
5,5	8,7	25	11,8	10 009000055
6	9,3	25	11,8	10 009000060
7	10,4	25	11,8	10 009000070
8	11,8	25	12,7	10 009000080
9	12,7	25	11,8	10 009000090
10	14,2	25	12,0	10 009000100
11	15,8	25	12,5	10 009000110
12	17,2	25	13,5	10 009000120
13	18,0	25	13,5	10 009000130
14	20,0	25	15,0	10 009000140



900/SB13
4-4,5-5-5,5-6-7-8-9
10-11-12-13-14 mm 1 009000150

900MC

hexagon hand sockets, coloured

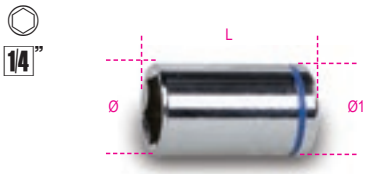

mm	L	Ø	Ø1	
4	24,8	6,7	11,8	5 009002040
5	24,8	8,0	11,8	5 009002050
6	24,8	9,2	11,8	5 009002060
7	24,8	10,7	11,8	5 009002070
8	24,8	11,8	11,8	5 009002080
9	24,8	12,8	12,8	5 009002090
10	24,8	14,8	14,8	5 009002100
11	24,8	15,8	15,8	5 009002110
12	24,8	16,8	16,8	5 009002120
13	24,8	17,8	17,8	5 009002130
14	24,8	19,5	19,5	5 009002140



900MB

bi-hex hand sockets



UNI/ISO 2725 DIN 3124

mm	Ø	L	Ø1	
4	6,7	22	11,2	5 009000160
5	7,7	25	11,2	5 009000161
5,5	8,3	25	11,2	5 009000162
6	9,0	25	11,2	5 009000163
7	10,2	25	11,2	5 009000164
8	11,3	25	12,0	5 009000165
9	13,0	25	12,0	5 009000166
10	14,3	25	12,9	5 009000167
11	16,0	25	14,3	5 009000168
12	17,4	25	16,0	5 009000169
13	18,0	25	16,4	5 009000170
14	19,3	25	17,9	5 009000171



900MB/SB12
4-5-5,5-6-7-8-9-10
11-12-13-14 mm 1 009000179

900L

hexagon hand sockets, long series



UNI/ISO 2725 DIN 3124

mm	Ø	L	Ø1	
4	6,5	50	12,0	5 009000181
4,5	7,0	50	12,0	5 009000182
5	7,5	50	12,0	5 009000183
5,5	8,5	50	12,0	5 009000184
6	9,5	50	12,0	5 009000185
7	10,5	50	12,0	5 009000186
8	12,0	50	12,0	5 009000187
9	13,0	50	13,0	5 009000188
10	14,0	50	14,0	5 009000189
11	16,0	50	16,0	5 009000190
12	17,5	50	17,5	5 009000191
13	17,5	50	17,5	5 009000192
14	20,0	50	20,0	5 009000193



900L/SB13
4-4,5-5-5,5-6-7-8-9-10-11-12-13-14 mm 1 009000203

900MB/L

bi-hex hand sockets, long series



UNI/ISO 2725 DIN 3124

mm	Ø	L	Ø1	
5	8,0	50	12,0	3 009000211
6	9,3	50	12,0	3 009000212
7	10,9	50	12,0	3 009000213
8	11,6	50	12,0	3 009000214
9	13,0	50	12,0	3 009000215
10	14,3	50	12,8	3 009000216
11	16,0	50	14,2	3 009000217
12	17,4	50	15,5	3 009000218
13	18,0	50	16,2	3 009000219
14	19,0	50	17,1	3 009000220

900AS

hexagon hand sockets



mm	Ø	L	Ø1	
5/32	8,8	25	11,9	5 009000349
3/16	7,7	25	11,9	5 009000340
7/32	8,8	25	11,9	5 009000345
1/4	9,6	25	11,9	5 009000350
9/32	10,2	25	11,9	5 009000355
5/16	11,3	25	11,9	5 009000360
11/32	12,7	25	11,6	5 009000365
3/8	14,0	25	12,9	5 009000370
7/16	15,3	25	14,5	5 009000375
1/2	17,5	25	16,4	5 009000380
9/16	19,0	25	17,9	5 009000385



900AS/SB11
3/16-7/32-5/32-1/4-9/32-5/16-11/32-3/8-
7/16-1/2-9/16 1 009000389

900AS/MB

bi-hex hand sockets



SAE AS 954E

"	Ø	L	Ø1	
3/16	7,7	22	10,9	2 009000390
7/32	8,5	22	10,9	2 009000391
1/4	9,4	22	10,9	2 009000392
9/32	10,2	22	10,9	2 009000393
5/16	11,3	22	11,7	2 009000394
11/32	12,5	22	12,0	2 009000395
3/8	13,7	22	12,9	2 009000396
7/16	15,6	22	14,3	2 009000397
1/2	17,2	22	16,4	2 009000398
9/16	18,8	24	17,9	2 009000399

900AS/L

hexagon hand sockets, long series

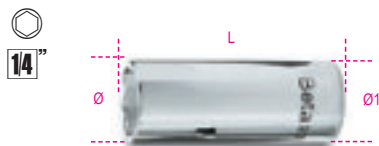

SAE AS 954E

"	Ø mm	L mm	Ø1 mm		
3/16	7,0	50	12,0	2	009000301
7/32	8,5	50	12,0	2	009000303
1/4	9,8	50	12,0	2	009000305
9/32	10,5	50	12,0	2	009000307
5/16	12,0	50	12,0	2	009000309
11/32	13,0	50	13,0	2	009000311
3/8	14,0	50	14,0	2	009000313
7/16	16,0	50	16,0	2	009000315
1/2	17,5	50	17,5	2	009000317
9/16	20,0	50	20,0	2	009000319

900AS/MBL

bi-hex hand sockets, long series



"	Ø mm	L mm	Ø1 mm		
5/32	6,8	50	12,0	2	009000325
3/16	8,0	50	12,0	2	009000326
7/32	8,5	50	12,0	2	009000327
1/4	9,8	50	12,0	2	009000328
9/32	10,9	50	12,0	2	009000329
5/16	11,6	50	12,0	2	009000330
11/32	13,0	50	12,0	2	009000331
3/8	14,3	50	12,8	2	009000332
7/16	16,0	50	14,2	2	009000333
1/2	18,0	50	16,2	2	009000334
9/16	19,0	50	17,1	2	009000335

900U

gear lock hand sockets



mm	"	Ø	Ø		
4	5/32	E5	M5	5	009001702
4,5	3/16	E6		5	009001703
5	13/64		M6	5	009001704
5,5	7/32	E7		5	009001705
6	1/4	E8	M8	5	009001706
7	9/32			5	009001707
8	5/16	E10	M10	5	009001708
9	11/32			5	009001709
10	3/8	E12	M12	5	009001710
11	7/16	E14	M14	5	009001711
12	15/32	E16		5	009001712
13	1/2		M16	5	009001713
14	9/16	E18	M18	5	009001714

1/4"



900U/SB13

4-4,5-5-5,5-6-7-8-9
10-11-12-13-14 mm

1 009001750

900FTX

hand sockets for Torx® head screws

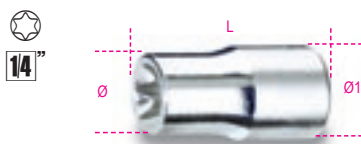

"	Ø mm	L mm	Ø1 mm		
E4	5,4	22	11,2	5	009000404
E5	6,7	22	11,2	5	009000405
E6	7,7	22	11,2	5	009000406
E7	8,3	22	11,2	5	009000407
E8	9,6	22	11,2	5	009000408
E10	11,3	22	12,0	5	009000410
E11	12,1	22	12,5	5	009000411
E12	12,9	23	12,9	5	009000412
E14	14,0	25	14,0	5	009000414

1/4"



900FTX/SB9

E4-E5-E6-E7-E8
E10-E11-E12-E14

1 009000419

900LP

socket drivers for slotted head screws

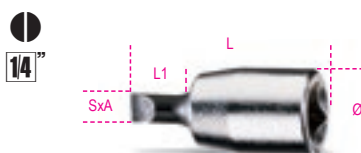

SxA mm	Ø mm	L mm	L1 mm		
0,8x4	12	28	9	5	009000605
1x5,5	12	28	9	5	009000610
1,2x6,5	12	28	9	5	009000615
1,2x8	13	28	8	5	009000620
1,6x10	14	28	8	5	009000625

900MC/LP

socket drivers
for slotted head screws, coloured

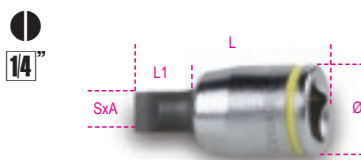

SxA mm	Ø mm	L mm	L1 mm		
0,8x4	12	28	9	3	009002605
1,2x6,5	12	28	9	3	009002615
1,2x8	13	28	8	3	009002620

900PH

socket drivers
for cross head Phillips® screws



PH	Ø mm	L mm	L1 mm		
1	12	28	12	5	009000701
2	12	28	12	5	009000702
3	12	28	12	5	009000703
4	13	28	11	5	009000704



900PH/SB4

PH1-PH2-PH3-PH4

1 009000708

900MC/PH

socket drivers
for cross head Phillips® screws, coloured



PH	Ø mm	L mm	L1 mm		
1	12	28	12	3	009002701
2	12	28	12	3	009002702
3	12	28	12	3	009002703

900PZ

socket drivers for cross head Pozidriv®-
Supadriv® screws



PZ	Ø mm	L mm		
1	12	28	3	009000711
2	12	28	3	009000712
3	12	28	3	009000713

900ME

socket drivers for hexagon screws



mm	Ø mm	L mm	L1 mm		
2,5	12	25	4,5	5	009000502
3	12	25	5,0	5	009000503
4	12	25	5,6	5	009000504
5	12	25	6,3	5	009000505
6	12	25	7,6	5	009000506
7	13	25	7,2	5	009000507
8	13	25	8,0	5	009000508
10	13	25	8,7	5	009000510



900ME/SB8	1	009000518
-----------	---	-----------

2,5-3-4-5-6-7-8-10 mm

900PE/AS

socket drivers for hexagon screws



"	Ø mm	L mm		
1/8	11,9	25	5	009000521
5/32	11,9	25	5	009000522
3/16	11,9	25	5	009000523
7/32	11,9	25	5	009000524
1/4	11,9	25	5	009000525
9/32	13,1	25	5	009000526
5/16	13,1	25	5	009000527

900PT

socket drivers for 5-star head screws



PT	Ø mm	L mm	L1 mm		
PT10	12	28	12	5	009000750
PT15	12	28	12	5	009000755
PT20	12	28	12	5	009000760
PT25	12	28	12	5	009000765
PT27	12	28	12	5	009000767
PT30	12	28	12	5	009000770

900TX

socket drivers for Torx® head screws



T	Ø mm	L mm	L1 mm		
T6	12	28	12	5	009000717
T7	12	28	12	5	009000718
T8	12	28	12	5	009000719
T9	12	28	12	5	009000720
T10	12	28	12	5	009000721
T15	12	28	12	5	009000722
T20	12	28	12	5	009000723
T25	12	28	12	5	009000724
T27	12	28	12	5	009000725
T30	12	28	12	5	009000726
T40	12	28	12	5	009000727



900TX/SB8	1	009000730
-----------	---	-----------

T9-T10-T15-T20
T25-T27-T30-T40

900MC/TX

socket drivers for Torx® head screws, coloured



T	Ø mm	L mm	L1 mm		
T10	12	28	12	3	009002721
T15	12	28	12	3	009002722
T20	12	28	12	3	009002723
T25	12	28	12	3	009002724
T27	12	28	12	3	009002725
T30	12	28	12	3	009002726
T40	12	28	12	3	009002727

900/16

adaptor, 1/4" female and 3/8" male drives



UNI/ISO 3316 DIN 3123

L mm	Ø mm				
28	13,0	1/4	3/8	5	009000814

900/...

1/4" female and male drive extension bars

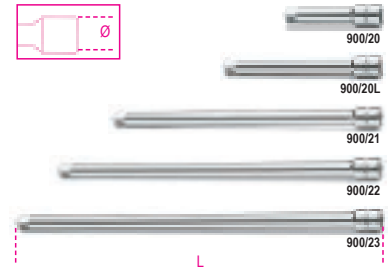

UNI/ISO 3316 DIN 3123

	L mm	Ø mm		
900/20	50	11,5	5	009000818
900/20L	100	11,5	5	009000819
900/21	150	11,5	5	009000822
900/22	250	11,5	5	009000823
900/23	350	11,5	5	009000824

900AN

1/4" wobble extension bars

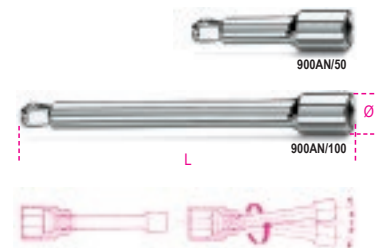

	L mm	Ø mm		
900AN/50	50	11,5	3	009000825
900AN/100	100	11,5	3	009000826

900FL

1/4" flexible universal extension bar

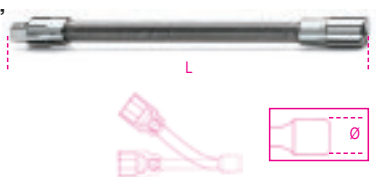

L mm	Ø mm			
150	12	3	009000828	

900/25

1/4" drive universal joint



UNI/ISO 3316 DIN 3123

L mm	Ø mm			
41	12,5	5	009000830	

900BG/30C

1/4" drive spinner handle

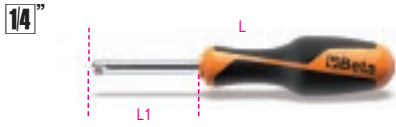

UNI/ISO 3315 DIN 3122

L	L1		
mm	mm		
128	20	5	009000833

900BG/30

1/4" drive spinner handle

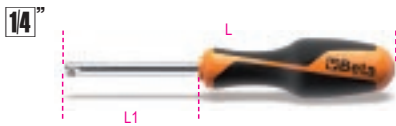

UNI/ISO 3315 DIN 3122

L	L1		
mm	mm		
176	68	5	009000834

900/32

1/4" drive flexible handle

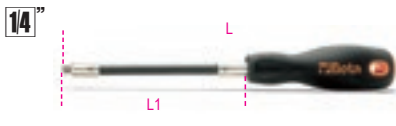

L	L1		
mm	mm		
280	154	2	009000839

900/35A

1/4" drive swivel handle



UNI/ISO 3315 DIN 3122

L	L1		
mm	mm		
148	84	5	009000840

900M/35

1/4" swivel drive with metal handle



UNI/ISO 3315
DIN 3122

L			
mm			
130		3	009000845



900/40

1/4" drive swivel T-handle



L	L1		
mm	mm		
390	145	3	009000843

900/42

1/4" drive sliding T-handle

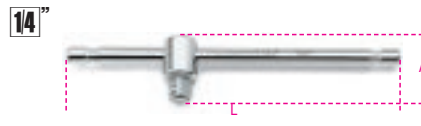

UNI/ISO 3315 DIN 3122

L	A		
mm	mm		
115	22	5	009000854

900T/44

1/4" male drive, bent,
with high torque handle



L	L1		
mm	mm		
238	105	2	009000860

900/55

1/4" drive reversible ratchet, 48 teeth



UNI/ISO 3315 DIN 3122

L	Ø	A	
mm	mm	mm	
125	25	29	5 009000870

900/55Z



Ratchet 900/55Z was developed by Beta's Technical Department with a new 72-tooth mechanism, 15 teeth being in contact with the gear at all times.

Therefore, the work load is distributed over a large number of teeth, thereby resulting in reduced wear of the individual parts and in an extremely long work life.



In addition, the 72 teeth ensure a take-up angle of no more than 5° and an extremely compact head, thereby providing quick access to smaller spaces as well.

Beta's ergonomic bi-material handle allows both quick use of the ratchet and the application of increased force.

900/55Z

1/4" drive reversible ratchet, 72 tooth mechanism



L	Ø	A	
mm	mm	mm	
126	25	23	3 009000882

900M/55

1/4" drive reversible ratchet with metal handle



UNI/ISO 3315			
DIN 3122			
L	Ø	A	
mm	mm	mm	
110	22	18	3 009000905

Spare parts
rotating mechanism of ratchets,
see table after item 929/C8

900/58

1/4" drive reversible ratchet with rotating handle, 52 tooth mechanism

- Socket release button
- Ring nut reversal system on ratchet head
- Bi-material handle



L	Ø	A	
mm	mm	mm	
126	28	28,5	2 009000884

900/C39N

11 hexagon sockets, 21 bits and 7 accessories



900/C39N			1 009000947
----------	--	--	-------------

861LP	0,6x4,5 - 1,2x6,5 - 1,2x8 mm
861PH	PH1-PH2-PH3
861PZ	PZ1-PZ2-PZ3
861PE	2,5-3-4-5-6 mm
861RTX	T10-T15-T20-T25-T27-T30-T40
900	5-5,5-6-7-8-9-10-11-12-13-14 mm
900/20	50 mm
900/20L	100 mm
900/25	
900BG/30C	128 mm
892/0	
895/1	
900/55Z	126 mm

900/C39U

11 gear lock sockets, 21 bits and 7 accessories



900/C39U			1 009001947
----------	--	--	-------------

861LP	0,6x4,5 - 1,2x6,5 - 1,2x8 mm
861PH	PH1-PH2-PH3
861PZ	PZ1-PZ2-PZ3
861PE	2,5-3-4-5-6 mm
861RTX	T10-T15-T20-T25-T27-T30-T40
900U	○ 5-5,5-6-7-8-9-10-11-12-13-14 mm * 3/16-13/64-7/32-1/4-9/32-5/16-11/32-3/8-7/16-15/32-1/2-9/16 ○ E6-E7-E8-E10-E12-E14-E16-E18 ○ M6-M8-M10-M12-M14-M16-M18
900/20	50 mm
900/20L	100 mm
900/25	
900BG/30C	128 mm
892/0	
895/1	
900/55Z	126 mm

900/C11

11 hexagon sockets, 20 bits and 8 accessories



900/C11			1 009000971
---------	--	--	-------------

861LP	0,5x3 - 0,8x5,5 1x5,5 - 1,2x6,5 mm
861PE	3 - 4 - 5 - 6 - 8 mm
861PH	0 - 1 - 2 - 3
861TX	T8 - T10 - T15 - T20 T25 - T30 - T40
895/1	
900	5 - 5,5 - 6 - 7 - 8 - 9 - 10 11 - 12 - 13 - 14 mm
900/16	□ 1/4 - ■ 3/8
900/20	50 mm
900/21	150 mm
900/25	
900BG/30	176 mm
900/42	
900/55	

270x120x45 mm - 1,2 kg

9899 900C11			1 098990132
Thermoformed tray, empty			

900/C11Z

11 hexagon sockets, 20 bits and 8 accessories



900/C11Z			1 009000984
----------	--	--	-------------

861LP	0,5x3 - 0,8x5,5 - 1x5,5 - 1,2x6,5 mm
861PE	3 - 4 - 5 - 6 - 8 mm
861PH	0 - 1 - 2 - 3
861TX	T8 - T10 - T15 - T20 T25 - T30 - T40
895/1	
900	5 - 5,5 - 6 - 7 - 8 - 9 - 10 11 - 12 - 13 - 14 mm
900/16	□ 1/4 - ■ 3/8
900/20	50 mm
900/21	150 mm
900/25	
900BG/30	176 mm
900/42	
900/55Z	

350x150x50 mm - 1,2 kg

9899 900C11			1 098990132
Thermoformed tray, empty			

900/C12MR

12 hexagon sockets, 20 bits and 7 accessories in foam tray, in metal case



900/C12MR			1 009000962
-----------	--	--	-------------

900	4-5-5,5-6-7-8-9-10-11-12-13-14 mm
900/20	50 mm
900/21	150 mm
900/25	
900/42	115 mm
900BG/30	128 mm
900/58	
895/1	
861TX	T8-T10-T15-T20-T25-T30-T40
861PH	PH0-PH1-PH2-PH3
861LP	0,5-0,8-1-1,2 mm
861PE	3-4-5-6-8 mm

350x150x50 mm 1,3 kg

900/C12MZ

12 hexagon sockets, 20 bits and 7 accessories in foam tray

1/4"

1/4"



900/C12MZ

1 009000983

- 900 4-5-5,5-6-7-8-9-10-11-12-13-14 mm
- 900/20 50 mm
- 900/21 150 mm
- 900/25
- 900/42 115 mm
- 900BG/30 176 mm
- 900/55Z
- 895/1
- 861TX T8-T10-T15-T20-T25-T30-T40
- 861PH PH0-PH1-PH2-PH3
- 861LP 0,5x3 - 0,8x5,5 - 1x5,5 - 1,2x6,5 mm
- 861PE 3-4-5-6-8 mm

350x150x50 mm - 1,2 kg

900/C13-5

13 hexagon sockets and 5 accessories

1/4"



900/C13-5

1 009000953

- 900 4-4,5-5-5,5-6-7-8-9-10-11-12-13-14 mm
- 900/21 150 mm
- 900/25
- 900BG/30
- 900/42
- 900/55

270x120x45 mm - 1 kg

9899 900/C13-5

Thermoformed tray, empty

1 098990131

900/C13-8

13 hexagon sockets and 8 accessories

1/4"



900/C13-8

1 009000954

- 900 4-4,5-5-5,5-6-7-8-9-10-11-12-13-14 mm
- 900/16 □ 1/4 - ■ 3/8
- 900/20 50 mm
- 900/21 150 mm
- 900/25
- 900BG/30
- 900/35A
- 900/42
- 900/55

270x120x45 mm - 1,1 kg

900MB/C19

11 bi-hex sockets and 8 accessories

1/4"



900MB/C19

1 009000977

- 900MB 5-5,5-6-7-8-9-10-11-12-13-14 mm
- 900/16 □ 1/4 - ■ 3/8
- 900/20 50 mm
- 900/21 150 mm
- 900/25
- 900BG/30
- 900/35A
- 900/42
- 900/55

270x120x45 mm - 1,1 kg

900/C24

13 hexagon sockets, 11 socket drivers and 6 accessories

1/4"



900/C24

1 009000956

- 900 4-4,5-5-5,5-6-7-8-9-10-11-12-13-14 mm
- 900LP 0,8x4 - 1,2x6,5 - 1,2x8 mm
- 900PH PH1 - PH2 - PH3
- 900ME 3-4-5-6-8 mm
- 900/20 50 mm
- 900/21 150 mm
- 900/25
- 900BG/30
- 900/42
- 900/55

270x120x45 mm - 1,1 kg

900MB/C28

11 bi-hex sockets, 11 socket drivers and 6 accessories

1/4"



900MB/C28

1 009000979

- 900MB 5-5,5-6-7-8-9-10-11-12-13-14 mm
- 900LP 0,8x4 - 1,2x6,5 - 1,2x8 mm
- 900PH PH1 - PH2 - PH3
- 900ME 3-4-5-6-8 mm
- 900/20 50 mm
- 900/21 150 mm
- 900/25
- 900BG/30
- 900/42
- 900/55

270x120x45 mm - 1,1 kg



900MC/C24

11 hexagon sockets, 13 coloured socket drivers and 6 accessories

1/4"



900MC/C24

1 009002960

	900MC	4 - 5 - 6 - 7 - 8 - 9 10 - 11 - 12 - 13 - 14 mm
	900MC/PH	PH1 - PH2 - PH3
	900MC/TX	T10 - T15 - T20 - T25 - T27 - T30 - T40
	900MC/LP	0,8x4 - 1,2x6,5 - 1,2x8 mm
	900/20	50 mm
	900/21	150 mm
	900/25	
	900BG/30	
	900/42	
	900/55	
270x120x45 mm - 1,1 kg		

900MC/C32

11 coloured sockets, 20 coloured bits and 7 accessories

1/4"



900MC/C32

1 009002963

	900MC	4 - 5 - 6 - 7 - 8 - 9 - 10 - 11 - 12 - 13 - 14 mm
	860LP	0,5x3 - 0,8x5,5 - 1,0x5,5 - 1,2x6,5 mm
	860PH	0 - 1 - 2 - 3
	860PE	3 - 4 - 5 - 6 - 8 mm
	860TX	T8 - T10 - T15 - T20 - T25 - T30 - T40
	895/1	
	900/20	
	900/21	
	900/25	
	900BG/30	
	900/42	
	900/55	
270x120x45 mm - 1,2 kg		

900U/C12M

12 gear lock hand sockets, 20 bits and 7 accessories, in soft foam tray

1/4"

1/4"



900U/C12M

1 009001792

	900U	○ 4-5-5,5-6-7-8-9-10-11-12-13-14 mm * 5/32-3/16-13/64-7/32-1/4-9/32-5/16 11/32-3/8-7/16-15/32-1/2-9/16 ○ E5-E6-E7-E8-E10-E12-E14-E16-E18 ○ M5-M6-M8-M10-M12-M14-M16-M18
	900/20	50 mm
	900/21	150 mm
	900/25	
	900/42	115 mm
	900BG/30	176 mm
	900/55	125 mm
	895/1	○ 1/4 - □ 1/4
	861LP	0,5x3 - 0,8x5,5 - 1,0x5,5 - 1,2x6,5 mm
	861PE	3-4-5-6-8 mm
	861PH	PH0-PH1-PH2-PH3
	861TX	T8-T10-T15-T20-T25-T30-T40
350x150x50 mm - 1,2 kg		

900AS/C10 - /MB-C17

10 sockets and 7 accessories

1/4"



900AS/C10

1 009000961

	900AS	3/16 - 7/32 - 1/4 - 9/32 - 5/16 11/32 - 3/8 - 7/16 - 1/2 - 9/16
	900/20	50 mm
	900/21	150 mm
	900/25	
	900BG/30	
	900/35A	
	900/42	
	900/55	
270x120x45 mm - 1,1 kg		

900AS/MB-C17

1 009000981

	900AS/MB	3/16 - 7/32 - 1/4 - 9/32 - 5/16 11/32 - 3/8 - 7/16 - 1/2 - 9/16
	900/20	50 mm
	900/21	150 mm
	900/25	
	900BG/30	
	900/35A	
	900/42	
	900/55	
270x120x45 mm - 1,1 kg		

900AS/C17-MBM

10 bi-hex sockets and 7 accessories for aeronautical maintenance

1/4"



900AS/C17-MBM

1 009000982

	900AS/MB	3/16 - 7/32 - 1/4 - 9/32 - 5/16 11/32 - 3/8 - 7/16 - 1/2 - 9/16
	900/20	50 mm
	900/21	150 mm
	900/25	
	900BG/30	
	900M/35	
	900/42	
	900M/55	
270x120x45 mm - 1,2 kg		



900/C11HR

11 hexagon sockets,
20 bits and 7 accessories
in hard foam tray,
in metal case

• ratchet with rotating handle

1/4
1/4"



900/C11HR

1 009000980

	861LP	0,5x3-0,8x5,5-1x5,5-1,2x6,5 mm
	861PH	PH0-PH1-PH2-PH3
	861PE	3-4-5-6-8 mm
	861TX	T8-T10-T15-T20-T25-T30-T40
	895/1	
	900	5-5,5-6-7-8-9-10-11-12-13-14 mm
	900/16	□ 1/4 - ■ 3/8
	900/20	50 mm
	900/21	150 mm
	900/25	
	900/42	
	900BG/30	
	900/58	

350x150x50 mm - 1,3 kg

902R/C6

6 adaptors for socket drivers



902R/C6

1 009020814

	900/16	□ 1/4 - ■ 3/8
	910/15	□ 3/8 - ■ 1/4
	910/16	□ 3/8 - ■ 1/2
	920/15	□ 1/2 - ■ 3/8
	920/16	□ 1/2 - ■ 3/4
	928/15	□ 3/4 - ■ 1/2

170x100x35 mm - 600 g

902A/C22

22 hexagon sockets and 6 accessories in metal case

1/4
1/2"



902A/C22

1 009020807

	900	5-5,5-6-7-8-9-10-11-12-13 mm
	900/20	50 mm
	900/25	
	900/55	
	920A	10-13-14-15-17-18-19-22-24-27-30-32 mm
	920/21	125 mm
	920/25	
	920/55	

420x185x60 mm - 3,5 kg

9899 902A/C22

1 098990133

Thermoformed tray, empty

910A

hexagon hand sockets

3/8"



UNI/ISO 2725 DIN 3124

mm	Ø	L	Ø1	
6	9,5	28	16,7	5 009100006
7	10,7	28	16,7	5 009100007
8	12,1	28	16,7	5 009100008
9	13,2	28	16,7	5 009100009
10	14,6	29	16,7	5 009100010
11	15,8	29	16,7	5 009100011
12	17,2	30	17,7	5 009100012
13	18,4	31	17,0	5 009100013
14	19,7	32	17,5	5 009100014
15	20,9	32	18,0	5 009100015
16	22,2	33	18,5	5 009100016
17	23,2	33	19,0	5 009100017
18	24,7	34	20,0	5 009100018
19	25,8	35	21,0	5 009100019
20	27,2	35	22,0	5 009100020
21	28,2	36	23,0	5 009100021
22	29,7	37	24,0	5 009100022

3/8"



910A/SB17

1 009100030

6-7-8-9-10-11-12
13-14-15-16-17
18-19-20-21-22 mm

910B

bi-hex hand sockets

3/8"



UNI/ISO 2725 DIN 3124

mm	Ø	L	Ø1	
6	9,5	28	16,7	5 009100106
7	10,7	28	16,7	5 009100107
8	12,1	28	16,7	5 009100108
9	13,2	28	16,7	5 009100109
10	14,6	29	16,7	5 009100110
11	15,8	29	16,7	5 009100111
12	17,2	30	17,7	5 009100112
13	18,4	31	17,0	5 009100113
14	19,7	32	17,5	5 009100114
15	20,9	32	18,0	5 009100115
16	22,2	33	18,5	5 009100116
17	23,2	33	19,0	5 009100117
18	24,7	34	20,0	5 009100118
19	25,8	35	21,0	5 009100119
20	27,2	35	22,0	5 009100120
21	28,2	36	23,0	5 009100121
22	29,7	37	24,0	5 009100122

3/8"



910B/SB17

1 009100130

6-7-8-9-10-11-12
13-14-15-16-17
18-19-20-21-22 mm

910AL

hexagon hand sockets,
long series

3/8"



UNI/ISO 2725 DIN 3124

mm	Ø	L	Ø1	
8	12,0	55	17	3 009100158
9	13,0	55	17	3 009100159
10	14,5	55	17	3 009100160
11	16,0	55	17	3 009100161
12	17,0	55	17	3 009100162
13	18,0	55	17	3 009100163
14	20,0	55	18	3 009100164
15	21,0	55	20	3 009100165
16	22,0	55	20	3 009100166
17	23,5	55	22	3 009100167
18	24,5	55	23	2 009100168
19	25,0	55	24	2 009100169
21	27,0	65	26	2 009100171
22	29,0	65	28	2 009100172

910AL/SB14

1 009100174

8-9-10-11-12-13-14
15-16-17-18-19-21-22 mm

910BL

bi-hex hand sockets, long series



UN/ISO 2725 DIN 3124

mm	Ø	L	Ø1	
8	12,0	55	17	3 009100308
9	13,0	55	17	3 009100309
10	14,5	55	17	3 009100310
11	16,0	55	17	3 009100311
12	17,0	55	17	3 009100312
13	18,0	55	17	3 009100313
14	20,0	55	18	3 009100314
15	21,0	55	20	3 009100315
16	22,0	55	20	3 009100316
17	23,5	55	22	3 009100317
18	24,5	55	23	2 009100318
19	25,0	55	24	2 009100319
21	27,0	65	26	2 009100321
22	29,0	65	28	2 009100322



910BL/SB14
8-9-10-11-12-13
14-15-16-17-18
19-21-22 mm
1 009100340

910B/SN

swivel end bi-hex hand sockets



mm	Ø	L	Ø1	
10	14,5	48,5	19	2 009100230
11	15,8	49,5	19	2 009100231
12	17,0	50,0	19	2 009100232
13	18,3	51,0	19	2 009100233
14	19,5	51,0	19	2 009100234
15	20,8	53,5	19	2 009100235
16	22,0	53,5	19	2 009100236
17	23,3	54,5	19	2 009100237
18	24,5	54,5	19	2 009100238
19	25,8	56,5	19	2 009100239

910A/AS

hexagon hand sockets

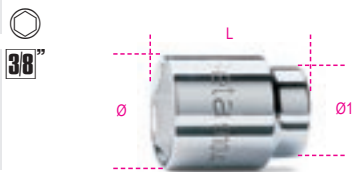

mm	Ø	L	Ø1	
5/16	10,3	26	17,3	5 009100276
1/4	11,9	26	17,3	5 009100278
11/32	13,3	26	17,3	5 009100279

"	Ø	L	Ø1	
3/8	13,9	26	17,3	5 009100280
7/16	15,8	26	17,3	5 009100281
1/2	17,9	26	17,3	5 009100283
9/16	19,5	27	18,5	5 009100284
19/32	20,6	27	19,5	5 009100285
5/8	21,9	28	20,0	5 009100286
11/16	24,6	30	22,5	5 009100287
3/4	25,9	30	23,5	5 009100289
13/16	27,9	32	26,0	5 009100291
7/8	29,6	32	26,5	5 009100292



910A-AS/SB13
1/4-5/16-11/32-3/8-7/16
1/2-9/16-19/32-5/8-11/16
3/4-13/16-7/8
1 009100295

910AS

bi-hex hand sockets

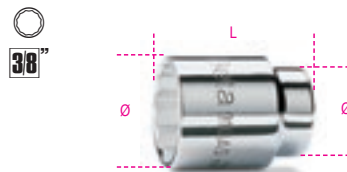

"	Ø	L	Ø1	
1/4	9,5	28	16,7	5 009100201
5/16	12,1	28	16,7	5 009100202
11/32	13,2	28	16,7	5 009100203
3/8	14,6	29	16,7	5 009100204
7/16	15,8	29	16,7	5 009100205
1/2	18,4	31	17,0	5 009100206
9/16	19,7	32	17,5	5 009100207
19/32	20,9	32	18,0	5 009100208
5/8	22,2	33	18,5	5 009100209
11/16	24,7	34	20,0	5 009100210
3/4	25,8	35	21,0	5 009100211
13/16	28,2	36	23,0	5 009100212
7/8	29,7	37	24,0	5 009100213



910AS/SB13
1/4-5/16-11/32-3/8-7/16
1/2-9/16-19/32-5/8-11/16
3/4-13/16-7/8
1 009100215

910AS/L

bi-hex hand sockets, long series

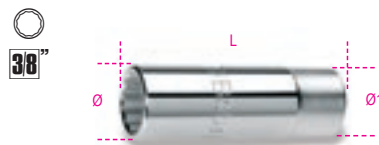

"	Ø	L	Ø1	
1/4	10	55	17	3 009100350
5/16	12	55	17	3 009100351
3/8	14	55	17	3 009100352
7/16	16	55	17	3 009100353
1/2	18	55	17	3 009100354
9/16	20	55	18	3 009100355

"	Ø	L	Ø1	
19/32	21	55	20	3 009100356
5/8	22	55	20	3 009100357
11/16	23	55	22	3 009100359
3/4	25	55	24	3 009100360
13/16	27	65	26	3 009100362
7/8	29	65	28	3 009100363



910ASL/SB12
1/4-5/16-3/8-7/16
1/2-9/16-19/32-5/8-11/16
3/4-13/16-7/8
1 009100365

910AS/SN

swivel end bi-hex hand sockets



* SAE AS 954E

"	Ø	L	Ø1	
* 3/8	14,0	48,0	19	2 009100260
* 7/16	15,8	51,0	19	2 009100261
* 1/2	18,3	51,0	19	2 009100262
* 9/16	19,5	51,0	19	2 009100263
* 5/8	22,0	53,5	19	2 009100264
11/16	24,5	54,5	19	2 009100265
3/4	25,8	56,5	19	2 009100266

910FTX

hand sockets for Torx® head screws

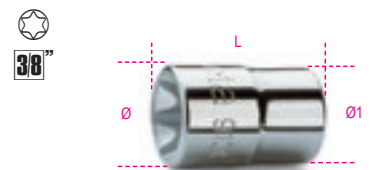

mm	Ø	L	Ø1	
E4	6,2	26	17,3	5 009100404
E5	7,0	26	17,3	5 009100405
E6	8,3	26	17,3	5 009100406
E7	8,9	26	17,3	5 009100407
E8	9,9	26	17,3	5 009100408
E10	12,0	26	17,3	5 009100410
E11	13,3	26	17,3	5 009100411
E12	14,5	26	17,3	5 009100412
E14	15,8	26	17,3	5 009100414
E16	18,0	26	17,3	5 009100416
E18	19,5	26	18,5	3 009100418
E20	21,9	26	20,0	3 009100420



910FTX/SB9
E4-E5-E6-E7-E8
E10-E12-14-E16
1 009100430

910FTX/L

hand sockets for Torx® head screws, long series



	Ø mm	L mm	Ø1 mm		
E4	6,2	55	17,3	3	009100440
E5	7,0	55	17,3	3	009100441
E6	8,3	55	17,3	3	009100442
E7	8,9	55	17,3	3	009100443
E8	9,9	55	17,3	3	009100444
E10	12,0	55	17,3	3	009100445



910FTX-L/SB6
E4-E5-E6
E7-E8-E10
1 009100449

910FTX/XL

hexagon hand sockets for Torx® head screws, extra-long series



	Ø mm	L mm	Ø1 mm		
E6	8,0	200	18	2	009100766
E7	8,0	200	18	2	009100767
E8	10,0	200	18	2	009100768
E10	14,0	200	18	2	009100770
E11	14,0	200	18	2	009100771
E12	14,0	200	18	2	009100772
E14	17,0	200	18	2	009100774
E16	18,6	200	18	2	009100776
E18	21,5	200	18	2	009100778
E20	21,5	200	18	2	009100780

910FTX-XL/C10

set of 10 hand sockets for Torx® head screws, long series, in plastic case



910FTX-XL/C10
E6-E7-E8-E10-E11-
E12-E14-E16-E18-E20
1 009100976

255x195x62 mm - 2,3 kg

910LP

socket drivers for slotted head screws

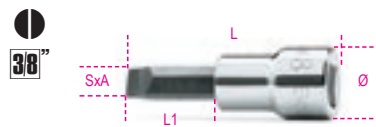

SxA mm	Ø mm	L mm	L1 mm		
1x5,5	18,5	54	24	2	009100452
1,2x6,5	18,5	54	24	2	009100453
1,2x8	18,5	54	24	2	009100454
1,6x9	18,5	54	24	2	009100456

910PH

socket drivers for cross head Phillips® screws



PH	Ø mm	L mm	L1 mm		
1	18,5	48	18	2	009100471
2	18,5	48	18	2	009100472
3	18,5	48	18	2	009100473
4	18,5	48	18	2	009100474



910PH/SB4
PH1-PH2-PH3-PH4
1 009100478

910PE

socket drivers for hexagon screws



DIN 7422

mm	Ø mm	L mm	L1 mm		
3	18,5	50	20	5	009100490
4	18,5	50	20	5	009100492
5	18,5	50	20	5	009100494
6	18,5	50	20	5	009100496
7	18,5	50	20	5	009100497
8	18,5	50	20	5	009100498
9	18,5	50	20	5	009100499
10	18,5	50	20	5	009100500



910PE/SB7
3-4-5-6-7-8-10 mm
1 009100503

910BP

ball head socket drivers for hexagon screws



mm	L mm	L1 mm		
4L	92	62	3	009100584
5L	92	62	3	009100585
6L	92	62	3	009100586
7L	92	62	3	009100587
8L	92	62	3	009100588
10L	132	102	3	009100590



910BP/SB6L
4L-5L-6L-7L-8L-10L mm
1 009100596

910ME

socket drivers for hexagon screws



mm	Ø mm	L mm	L1 mm		
4	18	62	15	5	009100504
5	18	62	15	5	009100505
6	18	62	15	5	009100506
7	18	62	15	5	009100507
8	19	62	15	5	009100508
10	20	62	15	5	009100510
12	20	62	15	5	009100512



910ME/SB5
4-5-6-8-10 mm
1 009100515

910PE/AS

socket drivers for hexagon screws

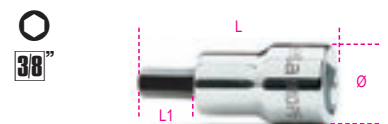

"	Ø mm	L mm	L1 mm		
1/8	18,5	50	20	2	009100531
5/32	18,5	50	20	2	009100532
3/16	18,5	50	20	2	009100533
7/32	18,5	50	20	2	009100534
1/4	18,5	50	20	2	009100535
5/16	18,5	50	20	2	009100536
3/8	18,5	50	20	2	009100537

910PT

socket drivers for 5-star head screws

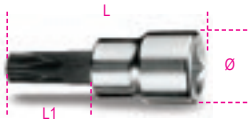

	Ø mm	L mm	L1 mm		
PT40	20	50	20	3	009100540
PT45	20	50	20	3	009100545
PT50	20	50	20	3	009100550



910PT/SB8	1	009100558
PT10-PT15-PT20-PT25		
PT30-PT40-PT45-PT50		

910TX

socket drivers for Torx® head screws



	Ø mm	L mm	L1 mm		
T15	18,5	50	20	5	009100519
T20	18,5	50	20	5	009100520
T25	18,5	50	20	5	009100521
T27	18,5	50	20	5	009100522
T30	18,5	50	20	5	009100523
T40	18,5	50	20	5	009100524
T45	18,5	50	20	3	009100525
T50	18,5	50	20	3	009100526



910TX/SB6	1	009100530
T15-T20-T25		
T27-T30-T40		

910XZN

socket drivers with XZN® profile



	L mm		
M4	50	3	009100559
M5	50	3	009100560
M6	50	3	009100561
M8	50	3	009100563
M10	50	3	009100565

910CF

3/8" square drive crowfoot wrenches



mm	A mm	L mm		
10	21,3	32,3	2	009100135
11	23,1	34,3	2	009100136
12	25,5	36,2	2	009100137
13	26,9	37,4	2	009100138
14	30,2	40,0	2	009100139
15	33,3	41,3	2	009100140
16	33,3	41,3	2	009100141
17	38,1	46,5	2	009100142
18	38,1	46,5	2	009100143
19	39,6	48,0	2	009100144



910CF/SB10	1	009100147
10-11-12-13-14-15		
16-17-18-19 mm		

910/15

adaptor, 3/8" female and 1/4" male drivers



UNI/ISO 3316 DIN 3123

L mm	Ø mm	□	■		
30	17,0	3/8	1/4	5	009100810



Always apply torque loads evenly and progressively to avoid breakage and any possible injury.

910/16

adaptor, 3/8" female and 1/2" male drives



UNI/ISO 3316 DIN 3123

L mm	Ø mm	□	■		
32	18,0	3/8	1/2	5	009100814



910/20 - 910/21 - 910/22

3/8" drive extension bars

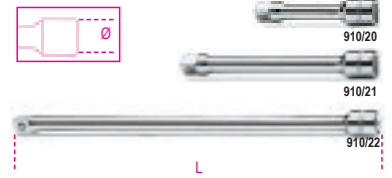

UNI/ISO 3316 DIN 3123

	L mm	Ø mm		
910/20	75	17	5	009100820
910/21	125	17	5	009100822
910/22	250	17	5	009100826

910AN

3/8" wobble extension bars

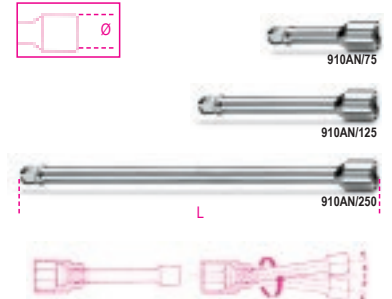

	L mm	Ø mm		
910AN/75	75	17	3	009100827
910AN/125	125	17	3	009100828
910AN/250	250	17	3	009100829

910/25

3/8" drive universal joint



UNI/ISO 3316 DIN 3123

L mm	Ø mm		
54,6	19	5	009100830

910M/35

3/8" swivel drive with metal handle



UNI/ISO 3315 DIN 3122

L mm		
250	3	009100839

910/36A

3/8" drive swivel handle

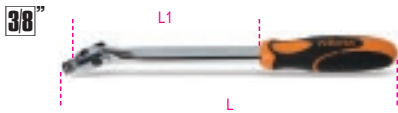

UNI/ISO 3315 DIN 3122

L	L1
mm	mm
255	154

3 009100845

910/40

3/8" drive swivel T-handle



L	L1
mm	mm
420	175

3 009100850

910/42

3/8" drive sliding T-handle

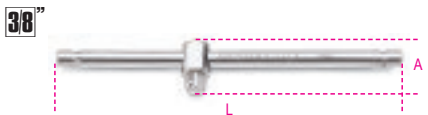

UNI/ISO 3315 DIN 3122

L	A
mm	mm
210	30,5

5 009100854

910/46

3/8" square drive with speed brace

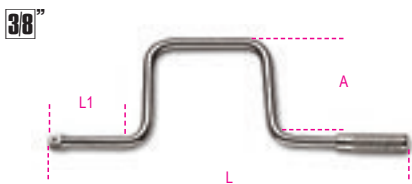

UNI/ISO 3315 DIN 3122

L	L1	A
mm	mm	mm
315	80	115

1 009100862

910/55

3/8" drive reversible ratchet 72 teeth



UNI/ISO 3315 DIN 3122

L	Ø	A
mm	mm	mm
200	30	33

3 009100882

910/55Q

3/8" drive reversible ratchet 48 teeth



UNI/ISO 3315 DIN 3122

L	Ø	A
mm	mm	mm
200	30	33

3 009100885

Spare parts
rotating mechanism of ratchets,
see table after item 929/C8

910M/55

3/8" drive reversible ratchet
with metal handle



DIN 3122 - UNI ISO 3315

L	Ø	A
mm	mm	mm
178	30	26

2 009100875

910M/56

3/8" drive reversible swivel ratchet
with metal handle



L	Ø	A
mm	mm	mm
265	31	29

2 009100887

910/58

3/8" drive reversible ratchet
with rotating handle,
52 tooth mechanism

- Socket release button
- Ring nut reversal system on ratchet head
- Bi-material handle



L	Ø	A
mm	mm	mm
222	37	38,5

1 009100884

910.../C10

10 sockets and 2 accessories



910A/C10

1 009100909

	910A	6 - 7 - 8 - 10 - 11 - 12 13 - 14 - 17 - 19 mm
	910/21	125 mm
	910/55	
≡ 270x120x45 mm - 1,3 kg		

910B/C10

1 009100910

	910B	6 - 7 - 8 - 10 - 11 - 12 13 - 14 - 17 - 19 mm
	910/21	125 mm
	910/55	
≡ 270x120x45 mm - 1,3 kg		

910A/C16...

16 hexagon sockets and 5 accessories



910A/C16

1 009100936

	910A	6 - 7 - 8 - 9 - 10 - 11 - 12 - 13 14 - 15 - 16 - 17 - 18 - 19 21 - 22 mm
	910/21	125 mm
	910/22	250 mm
	910/25	
	910/42	
	910/55	
≡ 335x145x60 mm - 2,3 kg		

9899 910C16

1 098990134

Thermoformed tray, empty

910A/C16Q

1 009100932

	910A	6 - 7 - 8 - 9 - 10 - 11 - 12 - 13 14 - 15 - 16 - 17 - 18 - 19 21 - 22 mm
	910/21	125 mm
	910/22	250 mm
	910/25	
	910/42	
	910/55Q	
≡ 335x145x60 mm - 2,3 kg		

9899 910C16

1 098990134

Thermoformed tray, empty

910B/C16...

16 bi-hex sockets and 5 accessories

38"



910B/C16 1 009100937

	○ 910B	6 - 7 - 8 - 9 - 10 - 11 - 12 - 13 14 - 15 - 16 - 17 - 18 - 19 21 - 22 mm
	910/21	125 mm
	910/22	250 mm
	910/25	
	910/42	
	910/55	
		335x145x60 mm - 2,3 kg

9899 910C16 1 098990134
Thermoformed tray, empty

910B/C16Q 1 009100933

	○ 910B	6 - 7 - 8 - 9 - 10 - 11 - 12 - 13 14 - 15 - 16 - 17 - 18 - 19 21 - 22 mm
	910/21	125 mm
	910/22	250 mm
	910/25	
	910/42	
	910/55Q	
		335x145x60 mm - 2,3 kg

9899 910C16 1 098990134
Thermoformed tray, empty

910A/C17

17 hexagon sockets and 9 accessories

38"



910A/C17 1 009100938

	○ 910A	6 - 7 - 8 - 9 - 10 - 11 - 12 - 13 14 - 15 - 16 - 17 - 18 - 19 - 20 21 - 22 mm
	910/15	□ 3/8 - ■ 1/4
	910/16	□ 3/8 - ■ 1/2
	910/21	125 mm
	910/22	250 mm
	910/25	
	910/36A	
	910/42	
	910/46	
	910/55	
		420x280x60 mm - 4,0 kg

910.../C29

17 sockets, 12 socket drivers
and 5 accessories

38"



910A/C29 1 009100944

	○ 910A	6 - 7 - 8 - 9 - 10 - 11 - 12 - 13 14 - 15 - 16 - 17 - 18 - 19 - 20 21 - 22 mm
	910LP	1x5,5 - 1,2x6,5 - 1,2x8 mm
	910PH	PH1 - PH2 - PH3
	○ 910PE	3 - 4 - 5 - 6 - 8 - 10 mm
	910/21	125 mm
	910/22	250 mm
	910/25	
	910/42	
	910/55	
		420x185x60 mm - 3,5 kg

910B/C29 1 009100945

	○ 910B	6 - 7 - 8 - 9 - 10 - 11 - 12 - 13 14 - 15 - 16 - 17 - 18 - 19 - 20 21 - 22 mm
	910LP	1x5,5 - 1,2x6,5 - 1,2x8 mm
	910PH	PH1 - PH2 - PH3
	○ 910PE	3 - 4 - 5 - 6 - 8 - 10 mm
	910/21	125 mm
	910/22	250 mm
	910/25	
	910/42	
	910/55	
		420x185x60 mm - 3,5 kg

910AS/C13...

13 bi-hex sockets and 5 accessories

38"



910AS/C13 1 009100925

	○ 910AS	1/4 - 5/16 - 11/32 - 3/8 - 7/16 1/2 - 9/16 - 19/32 - 5/8 - 11/16 3/4 - 13/16 - 7/8
	910/21	125 mm
	910/22	250 mm
	910/42	
	910/25	
	910/55	
		335x145x60 mm - 2,3 kg

910AS/MBM-C18

13 bi-hex sockets and 5 accessories
for aeronautical maintenance

38"



910AS/MBM-C18 1 009100926

	○ 910AS	1/4 - 5/16 - 11/32 - 3/8 - 7/16 1/2 - 9/16 - 19/32 - 5/8 - 11/16 3/4 - 13/16 - 7/8
	910/21	125 mm
	910/22	250 mm
	910/25	
	910/42	
	910M/55	
		335x145x60 mm - 2,5 kg

910A/C16HR

16 hexagon sockets and 5 accessories

38"



910A/C16HR 1 009100935

	○ 910A	6 - 7 - 8 - 9 - 10 - 11 - 12 - 13 14 - 15 - 16 - 17 - 18 - 19 21 - 22 mm
	910/21	125 mm
	910/22	250 mm
	910/25	
	910/42	210 mm
	910/58	
		335x145x60 mm - 2,4 kg



920A

hexagon hand sockets



UNI/ISO 2725 DIN 3124

mm	Ø	L	Ø1		
8	12,4	38	21,7	10	009200008
9	13,5	38	21,7	10	009200009
10	14,9	38	21,7	10	009200010
11	16,1	38	21,7	10	009200011
12	17,5	38	21,7	10	009200012
13	18,7	38	21,7	10	009200013
14	20,1	38	21,7	10	009200014
15	21,5	38	22,5	10	009200015
16	22,7	38	23,7	10	009200016
17	24,1	38	23,1	10	009200017
18	25,3	39	24,0	10	009200018
19	26,6	39	24,0	10	009200019
20	27,8	40	25,0	5	009200020
21	28,8	40	25,0	5	009200021
22	29,9	41	26,0	5	009200022
23	30,8	42	26,0	5	009200023
24	32,2	43	27,0	5	009200024
25	33,2	44	27,0	5	009200025
26	34,7	45	28,0	5	009200026
27	36,2	46	29,0	5	009200027
28	37,2	47	30,0	5	009200028
29	38,6	48	31,0	5	009200029
30	40,2	48	32,0	5	009200030
32	42,3	49	34,0	5	009200032



920A/SB13

10-11-12-13-14-15-16
17-18-19-20-21-22 mm

1 009200040



920A/SB8

23-24-25-26-27-28-30-32 mm

1 009200042

920MC

hexagon hand sockets,
coloured



mm	Ø	L	Ø1		
8	13,2	38	22		5 009202008
10	15,3	38	22		5 009202010
11	16,5	38	22		5 009202011
12	17,8	38	22		5 009202012
13	19,0	38	22		5 009202013
14	20,3	38	22		5 009202014
15	21,6	38	22		5 009202015
16	23,0	38	23		5 009202016
17	23,9	38	24		5 009202017
18	25,0	38	25		5 009202018
19	26,5	38	24		5 009202019
21	28,8	38	27		3 009202021
22	29,9	40	28		3 009202022
24	32,8	40	30		3 009202024

920B

bi-hex hand sockets



UNI/ISO 2725 DIN 3124

mm	Ø	L	Ø1		
8	12,4	38	21,7	10	009200108
9	13,5	38	21,7	10	009200109
10	14,9	38	21,7	10	009200110
11	16,1	38	21,7	10	009200111
12	17,5	38	21,7	10	009200112
13	18,7	38	21,7	10	009200113
14	20,1	38	21,7	10	009200114
15	21,5	38	22,5	10	009200115
16	22,7	38	23,7	10	009200116
17	24,1	38	23,1	10	009200117
18	25,3	39	24,0	10	009200118
19	26,6	39	24,0	10	009200119
20	27,8	40	25,0	5	009200120
21	28,8	40	25,0	5	009200121
22	29,9	41	26,0	5	009200122
23	30,8	42	26,0	5	009200123
24	32,2	43	27,0	5	009200124
25	33,2	44	27,0	5	009200125
26	34,7	45	28,0	5	009200126
27	36,2	46	29,0	5	009200127
28	37,2	47	30,0	5	009200128
29	38,6	48	31,0	5	009200129
30	40,2	48	32,0	5	009200130
32	42,3	49	33,9	5	009200132



920B/SB13

10-11-12-13-14-15-16
17-18-19-20-21-22 mm

1 009200140



920B/SB8
23-24-25-26-27
28-30-32 mm

1 009200142

920AL

hexagon hand sockets,
long series



UNI/ISO 2725 DIN 3124

mm	Ø	L	Ø1		
10	14,7	77	21	5	009200626
12	17,8	77	21	5	009200627
13	19,0	77	22	5	009200628
14	20,3	77	22	5	009200629
15	21,5	77	22	5	009200630
16	22,8	77	22	5	009200631
17	24,0	77	23	5	009200632
18	25,0	77	24	5	009200633
19	26,5	77	25	5	009200634
21	29,0	77	27	5	009200635
22	30,0	77	28	5	009200636
23	31,5	77	29	5	009200637
24	32,8	77	30	5	009200638
27	36,5	77	33	3	009200639
30	40,0	77	36	3	009200640
32	42,8	77	38	3	009200641
36	48,0	77	41	3	009200642



920AL/SB11
10-12-13-14-15-16
17-18-19-21-22 mm

1 009200644

920BL

bi-hex hand sockets, long series



UNI/ISO 2725 DIN 3124

mm	Ø	L	Ø1		
10	14,7	77	21	5	009200310
12	17,8	77	21	5	009200312
13	19,0	77	22	5	009200313
14	20,3	77	22	5	009200314
15	21,5	77	22	5	009200315
16	22,8	77	22	5	009200316
17	24,0	77	23	5	009200317
18	25,0	77	24	5	009200318
19	26,5	77	25	5	009200319
21	29,0	77	27	5	009200321
22	30,0	77	28	5	009200322
23	31,5	77	29	5	009200323
24	32,8	77	30	5	009200324
27	36,5	77	33	3	009200327
30	40,0	77	36	3	009200330
32	42,8	77	38	3	009200332
36	48,0	77	41	3	009200336



920BL/SB11
10-12-13-14-15-16-17-18
19-21-22 mm

1 009200338



920A/AS

hexagon hand sockets



"	Ø mm	L mm	Ø1 mm		
3/8	14,6	37	21	2	009200270
7/16	16,5	37	21	3	009200272
1/2	19,0	37	22	3	009200273
9/16	20,3	37	22	3	009200274
19/32	21,0	37	22	3	009200275
5/8	22,8	37	22	3	009200276
11/16	25,0	37	24	3	009200277
3/4	26,5	38	25	3	009200279
25/32	28,0	38	26	3	009200280
13/16	29,0	38	27	3	009200281
7/8	30,0	40	28	3	009200282
15/16	32,8	42	30	3	009200284
1	35,0	42	32	3	009200285
1.1/16	36,5	43	33	2	009200287
1.1/8	39,0	43	35	2	009200289
1.3/16	41,0	46	36	2	009200290
1.1/4	42,8	46	38	2	009200292



920A-AS/SB11
3/8-7/16-1/2-9/16-5/8
11/16-3/4-13/16-7/8
15/16-1

920AS

bi-hex hand sockets

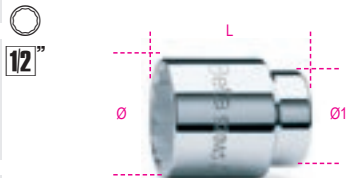

"	Ø mm	L mm	Ø1 mm		
3/8	14,9	38	21,7	3	009200201
7/16	16,1	38	21,7	3	009200202
1/2	18,7	38	21,7	3	009200203
9/16	20,1	38	21,7	3	009200204
5/8	22,7	38	22,5	3	009200206
19/32	21,5	38	23,7	3	009200207
11/16	25,3	39	24,0	3	009200208
3/4	26,6	39	24,0	3	009200209
25/32	27,8	40	25,0	3	009200210
13/16	28,8	40	25,0	3	009200211
7/8	29,9	41	26,0	3	009200212
15/16	32,2	43	27,0	3	009200214
1	34,2	45	28,0	3	009200216
1.1/16	36,2	46	29,0	2	009200217
1.1/8	38,6	48	31,0	2	009200218
1.3/16	40,2	48	32,0	2	009200219
1.1/4	42,3	49	33,5	2	009200220



920AS/SB11
3/8-7/16-1/2-9/16-5/8
11/16-3/4-13/16-7/8
15/16-1

920AS/L

bi-hex hand sockets, long series



"	Ø mm	L mm	Ø1 mm		
1/2	19,0	77	22	2	009200352
9/16	20,3	77	22	2	009200353
5/8	22,8	77	22	2	009200355
11/16	25,0	77	24	2	009200357
3/4	26,5	77	25	2	009200358
13/16	29,0	77	27	2	009200360
7/8	30,0	77	28	2	009200361
15/16	32,8	77	30	2	009200362
1	35,0	77	32	2	009200363
1.1/16	36,5	77	33,0	2	009200364
1.1/8	37,8	77	34	2	009200365



920ASL/SB11
1/2-9/16-5/8-11/16
3/4-13/16-7/8-15/16
1-1.1/8-1.1/16

920U

gear lock hand sockets



mm	"	Ø	M	L mm		
10	3/8	E12	M12	38	5	009201710
11	7/16	E14	M14	38	5	009201711
12	15/32	E16		38	5	009201712
13	1/2		M16	38	5	009201713
14	9/16	E18	M18	38	5	009201714
15	19/32			38	5	009201715
16	5/8	E20		38	5	009201716
17				38	5	009201717
18		E22		38	5	009201718
19	3/4	E24		38	5	009201719
20	25/32			38	3	009201720
21				38	3	009201721
22	7/8			38	3	009201722
24	15/16			38	3	009201724
27	1.1/16			42	3	009201727
30	1.1/8			44	3	009201730
32	1.1/4			44	3	009201732



920U/SB13
10-11-12-13-14-15-16
17-18-19-20-21-22 mm



920U/SB4
24-27-30-32 mm

920FTX

hand sockets for Torx® head screws

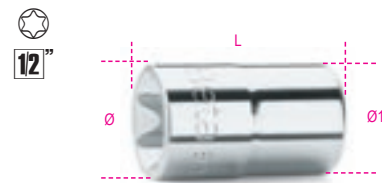

"	Ø mm	L mm	Ø1 mm		
E10	13,2	36	21	5	009200380
E12	15,0	37	21	5	009200381
E14	16,3	37	21	5	009200382
E16	18,8	37	22	5	009200383
E18	20,4	37	22	5	009200384
E20	22,9	37	22	5	009200385
E22	25,0	37	24	3	009200387
E24	26,5	40	25	3	009200388



920FTX/SB6
E10-E12-E14
E16-E18-E20



920FTX/C8
E10-E12-E14-E16
E18-E20-E22-E24
270X120X45 mm - 1 kg

920FTX/L

hand sockets for Torx® head screws, long series



"	Ø mm	L mm	Ø1 mm		
E10	13,2	77	21,0	5	009200400
E12	15,0	77	21,0	5	009200401
E14	16,3	77	21,0	5	009200402
E16	18,8	77	21,8	3	009200403
E18	20,4	77	21,8	3	009200404
E20	22,9	77	22,0	3	009200405



920FTX-LSB6
E10-E12-E14
E16-E18-E20

920LP

socket drivers for slotted head screws

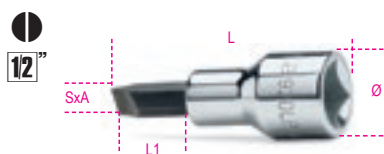

SxA	Ø	L	L1		
mm	mm	mm	mm		
1x5,5	22,5	62	24	3	009200452
1,2x6,5	22,5	62	24	3	009200453
1,2x8	22,5	62	24	3	009200454
1,6x9	22,5	62	24	3	009200456
2x12	22,5	62	24	3	009200458

920PH

socket drivers for cross head Phillips® screws



PH	Ø	L	L1		
	mm	mm	mm		
1	22,5	56	18	3	009200471
2	22,5	56	18	3	009200472
3	22,5	56	18	3	009200473
4	22,5	56	18	3	009200474



920PH/SB4 1 009200479
PH1-PH2-PH3-PH4

920LH/SB7

socket drivers for cross head Phillips® screws



920LH/SB7 1 009200478

920LP	1,2x6,5 - 1,2x8
920PH	1,6x9 - 2x12 mm
	PH2 - PH3 - PH4

920PE

socket drivers for hexagon screws

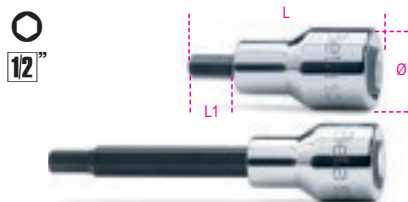

DIN 7422

mm	Ø	L	L1		
mm	mm	mm	mm		
3	22,5	58	20	5	009200410
4	22,5	58	20	5	009200412
5	22,5	58	20	5	009200414

mm	Ø	L	L1		
mm	mm	mm	mm		
5L	22,5	100	62	5	009200415
6	22,5	58	20	5	009200417
6L	22,5	100	62	5	009200418
7	22,5	58	20	5	009200420
7L	22,5	100	62	5	009200421
8	22,5	58	20	5	009200423
8L	22,5	100	62	5	009200424
9	22,5	58	20	5	009200425
9L	22,5	140	102	5	009200426
10	22,5	58	20	5	009200428
10L	22,5	140	102	5	009200429
12	23,0	58	20	5	009200432
12L	22,5	140	102	5	009200433
14	23,0	58	20	5	009200434
14L	22,5	140	102	5	009200435
17	29,5	60	22	5	009200437
19	29,5	60	22	5	009200439



920PE/SB9 1 009200441
4-5-6-8-10 mm
5L-6L-8L-10L mm



920PE/C10 1 009200443
4-5-6-7-8-10
12-14-17-19 mm
≡ 270X120X45 mm - 1,5 kg

9899 920PE/C10 1 098990135
Thermoformed tray, empty

920PE/AS

socket drivers for hexagon screws

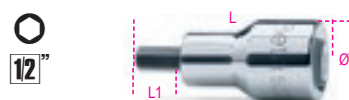

"	Ø	L	L1		
mm	mm	mm	mm		
1/8	22,5	58	20	2	009200460
3/16	22,5	58	20	2	009200461
1/4	22,5	58	20	2	009200463
3/8	22,5	58	20	2	009200464
1/2	22,5	60	20	2	009200465
3/4	22,5	60	20	1	009200468



920PE/AS/SB6 1 009200469
1/8-3/16-1/4-3/8-1/2-3/4

920BP

ball head socket drivers for hexagon screws

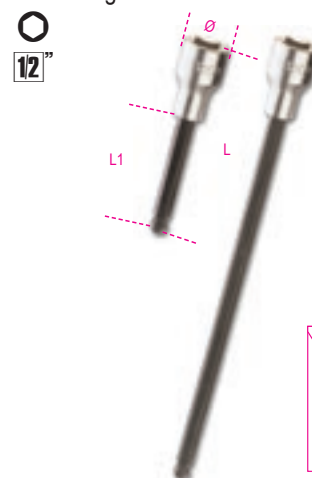

mm	Ø	L	L1		
mm	mm	mm	mm		
5L	22,5	100	62	5	009200490
5XL	22,5	240	202	1	009200495
6L	22,5	100	62	5	009200491
6XL	22,5	240	202	1	009200496
7L	22,5	100	62	5	009200492
8L	22,5	100	62	5	009200493
8XL	22,5	240	202	1	009200497
10L	22,5	140	102	5	009200494



920BP/SB8 1 009200500
5L-6L-7L-8L-10L mm
5XL-6XL-8XL mm

920ME

socket drivers for hexagon screws



mm	Ø	L	L1		
mm	mm	mm	mm		
5	21	75	15,5	5	009200505
6	21	75	15,5	5	009200506
7	21	75	15,5	5	009200507
8	21	75	15,5	5	009200508
10	23	75	15,5	5	009200510
12	24	75	15,5	5	009200512
14	24	75	15,5	5	009200514
17	24	75	15,5	5	009200517



920ME/SB7 1 009200519
5-6-8-10-12-14-17 mm

12"



920ME/C7
5-6-8-10-12-14-17 mm
1 009200518
250X100X35 mm - 1,4 kg

920TX

socket drivers for Torx® head screws

12"



Ø mm	L mm	L1 mm		
T20	22,5	58	20	5 009200520
T20L	22,5	120	82	3 009200530
T25	22,5	58	20	5 009200521
T25L	22,5	120	82	3 009200531
T27	22,5	58	20	5 009200522
T27L	22,5	120	82	3 009200533
T30	22,5	58	20	5 009200523
T30L	22,5	120	82	3 009200534
T40	22,5	58	20	5 009200524
T40L	22,5	120	82	3 009200535
T45	22,5	58	20	5 009200525
T45L	22,5	120	82	3 009200537
T50	22,5	58	20	5 009200526
T50L	23,0	140	102	3 009200538
T55	23,0	58	20	3 009200527
T55L	23,0	140	102	3 009200539
T60	23,0	58	20	3 009200528
T60L	23,0	140	102	3 009200540
T70L	23,0	120	82	3 009200541

12"



920TX-SB9
T20-T25-T27-T30
T40-T45-T50-T55-T60
1 009200532



920TX-L/SB10
T20L-T25L-T27L-T30L-T40L-
T45L-T50L-T55L-T60L-T70L
1 009200545

12"



920TX/C9
T20-T25-T27-T30-T40
T45-T50-T55-T60
270X120X45 mm - 1,2 kg
1 009200546

9899 920TX/C9
Thermoformed tray, empty
1 098990136

920RTX

socket drivers
for Tamper Resistant Torx® head screws

12"



Ø mm	L mm	L1 mm		
T20	22,5	58	20	5 009200370
T25	22,5	58	20	5 009200371
T27	22,5	58	20	5 009200372
T30	22,5	58	20	5 009200373
T40	22,5	58	20	5 009200374

12"



920RTX/SB5
T20-T25-T27-T30-T40
1 009200378

920XZN

socket drivers with XZN® profile

12"

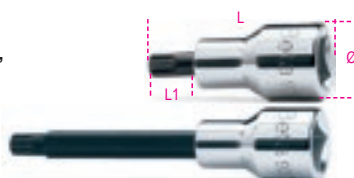

DIN 2324

Ø mm	L mm	L1 mm		
M4	22,5	58	20	3 009200559
M5	22,5	58	20	3 009200560
M6	22,5	58	20	3 009200561
M6L	22,5	100	62	3 009200562
M8	22,5	58	20	3 009200563
M8L	22,5	100	62	3 009200564
M9	22,5	58	20	3 009200582
M9L	22,5	100	62	3 009200583
M10	22,5	58	20	3 009200565
M10L	22,5	100	62	3 009200566
M12	22,5	58	20	3 009200568
M12L	22,5	100	62	3 009200569
M14	23,0	58	20	3 009200571
M14L	23,0	100	62	3 009200572
M16	23,0	58	20	3 009200573
M18	23,0	58	20	3 009200574

12"



920XZN/SB7
M4-M5-M6-M8
M10-M12-M14
1 009200579

12"



920XZN/SB12
M5-M6-M8-M10-M12
M14-M16-M6L-M8L
M10L-M12L-M14L
1 009200577

12"



920XZN-L/S5
M6L-M8L-M10L
M12L-M14L
1 009200578

920ES

special form socket drivers

12"



UNI 9326

Ø mm	Profile	L mm	L1 mm	
7	(6R)	58	20	5 009200587
7XL	(6R)	240	202	1 009200607
9	(8R)	58	20	5 009200589
9XL	(8R)	240	202	1 009200609
10	(8S)	58	20	5 009200590
10XL	(8S)	240	202	1 009200610
11	(10R)	58	20	5 009200591
11XL	(10R)	240	202	1 009200611
12L	(10S)	100	62	3 009200592
12XL	(10S)	240	202	1 009200612
14L	(12S)	100	62	3 009200594
14XL	(12S)	240	202	1 009200614
16L	(14R)	100	62	3 009200596
16XL	(14R)	240	202	1 009200616

12"



920ES/SB7
7-9-10-11-12L-14L-16L
1 009200598

12"



920ES-XL/SB7
7XL-9XL-10XL-11XL
12XL-14XL-16XL
1 009200618

PM 1/2-Q5

12"



PM 1/2-Q5
72,519

920/15

adaptor, 1/2" female and 3/8" male drives

12"



UNI/ISO 3316 DIN 3123

L	□	■	Ø	
mm	1/2	3/8	mm	
42			22,0	5 009200810



Always apply torque loads evenly and progressively to avoid breakage and any possible injury.

920/16

adaptor, 1/2" female and 3/4" male drives

12"



UNI/ISO 3316 DIN 3123

L	□	■	Ø	
mm	1/2	3/4	mm	
46			26	5 009200814

920/20÷920/23

1/2" drive extension bars

12"



UNI/ISO 3316 DIN 3123

	L	Ø	
	mm	mm	
920/20	75	22	5 009200818
920/21	125	22	5 009200822
920/22	255	22	5 009200826
920/23	375	22	2 009200827

920AN

1/2" wobble extension bars

12"

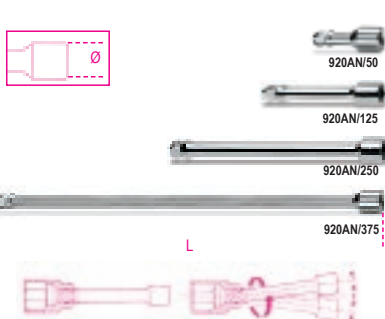

	L	Ø	
	mm	mm	
920AN/50	50	22	5 009200833
920AN/125	125	22	5 009200834
920AN/250	250	22	3 009200835
920AN/375	375	22	3 009200836

920/25

1/2" drive universal joint

12"



UNI/ISO 3316 DIN 3123

L	Ø	
mm	mm	
75	27	5 009200830

920/35A

1/2" drive swivel handle

12"



UNI/ISO 3315 DIN 3122

L	L1	
mm	mm	
285	160	3 009200846

920M/35

1/2" swivel drive with metal handle

12"



UNI/ISO 3315 DIN 3122

L	
mm	
380	2 009200845

920M/35L

1/2" swivel drive with metal handle, long series

12"



L	
mm	
600	1 009200843



Always apply torque loads evenly and progressively to avoid breakage and any possible injury.

920/36A

1/2" drive swivel handle

12"



UNI/ISO 3315 DIN 3122

L	L1	
mm	mm	
408	283	2 009200847

920/38

1/2" extension drive swivel handle

12"



L	L max	
mm	mm	
262	402	1 009200839

920/40

1/2" drive swivel T-handle

12"



L	L1	
mm	mm	
490	230	2 009200850

920/42

1/2" drive sliding T handle

12"

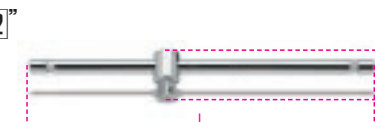

L	A	
mm	mm	
305	42	5 009200854

920/44

1/2" drive offset handle

12"



L	L1	
mm	mm	
230	60	3 009200858

920/46

1/2" drive with speed brace

12"

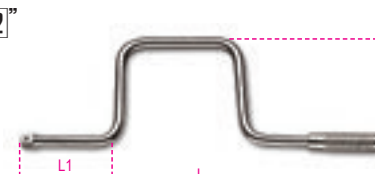

L	L1	A	
mm	mm	mm	
385	110	160	1 009200862

920/50

1/2" push-through drive ratchet,
72 teeth



UNI/ISO 3315 DIN 3122

L	Ø	A	
mm	mm	mm	
275	40	42	3 009200871

920/50F

1/2" female square drive ratchet,
72 teeth



UNI/ISO 3315 DIN 3122

L	Ø	A	
mm	mm	mm	
275	40	27	2 009200889

920/55

1/2" drive reversible ratchet,
72 teeth



UNI/ISO 3315 DIN 3122

L	Ø	A	
mm	mm	mm	
275	40	43	3 009200882

920/55Q

1/2" drive reversible ratchet, 48 teeth



UNI/ISO 3315 DIN 3122

L	Ø	A	
mm	mm	mm	
275	40	43	3 009200885

920/55X

1/2" drive reversible ratchet, 72 teeth



UNI/ISO 3315 DIN 3122

L	Ø	A	
mm	mm	mm	
200	30	33	3 009200895

920/55LC

1/2" drive reversible ratchet
"Locking System", 72 teeth



UNI/ISO 3315 DIN 3122

L	Ø	A	
mm	mm	mm	
275	40	43	2 009200896

920M/55

1/2" drive reversible ratchet
with metal handle



L	Ø	A	
mm	mm	mm	
253	38	35	1 009200893

920/56A

1/2" drive swivel reversible ratchet,
72 teeth



L	Ø	A	
mm	mm	mm	
315	40	43	1 009200911

920M/56

1/2" drive reversible swivel ratchet
with metal handle



L	Ø	A	
mm	mm	mm	
330	38	35,7	2 009200894

920/58

1/2" drive reversible ratchet
with rotating handle,
52 tooth mechanism

- Socket release button
- Ring nut reversal system on ratchet head
- Bi-material handle

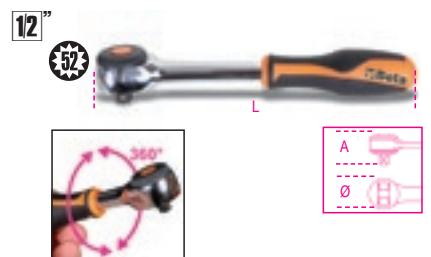

L	Ø	A	
mm	mm	mm	
281	42,5	45	1 009200926

Spare parts
rotating mechanism of ratchets,
see table after item 929/C8



920.../C11

11 sockets and 2 accessories

12"



920A/C11

1 009200921

	○ 920A	10 - 12 - 13 - 14 - 15 - 16 17 - 18 - 19 - 21 - 22 mm
	920/22	255 mm
	920/50	
≡ 335x145x60 mm - 2,5 kg		

920B/C11

1 009200922

	○ 920B	10 - 12 - 13 - 14 - 15 - 16 17 - 18 - 19 - 21 - 22 mm
	920/22	255 mm
	920/50	
≡ 335x145x60 mm - 2,5 kg		

920.../C12...

12 sockets and 5 accessories

12"



920A/C12X

1 009200933

	○ 920A	10 - 11 - 12 - 13 - 14 - 17 - 19 22 - 24 - 27 - 30 - 32 mm
	920/21	125 mm
	920/22	255 mm
	920/25	
	920/42	
	920/55	
≡ 420x185x60 mm - 4,2 kg		

9899 920C12
Thermoformed tray, empty

1 098990116

920A/C12

1 009200931

	○ 920A	10 - 11 - 12 - 13 - 14 - 17 - 19 22 - 24 - 27 - 30 - 32 mm
	920/21	125 mm
	920/22	255 mm
	920/25	
	920/42	
	920/50	
≡ 420x185x60 mm - 4,2 kg		

9899 920C12
Thermoformed tray, empty

1 098990116

920B/C12X

1 009200934

	○ 920B	10 - 11 - 12 - 13 - 14 - 17 - 19 22 - 24 - 27 - 30 - 32 mm
	920/21	125 mm
	920/22	255 mm
	920/25	
	920/42	
	920/55	
≡ 420x185x60 mm - 4,0 kg		

9899 920C12
Thermoformed tray, empty

1 098990116

920B/C12

1 009200932

	○ 920B	10 - 11 - 12 - 13 - 14 - 17 - 19 22 - 24 - 27 - 30 - 32 mm
	920/21	125 mm
	920/22	255 mm
	920/25	
	920/42	
	920/50	
≡ 420x185x60 mm - 4,0 kg		

9899 920C12
Thermoformed tray, empty

1 098990116

920MC/C14

14 coloured hexagon hand sockets and 5 accessories

12"

12"



920MC/C14

1 009202964

	○ 920MC	8 - 10 - 11 - 12 - 13 - 14 - 15 - 16 - 17 - 18 - 19 - 21 - 22 - 24 mm
	920/21	125 mm
	920/22	255 mm
	920/25	
	920/42	
	920/55	
≡ 420x185x60 mm - 4,2 kg		

920.../C20...

20 sockets and 5 accessories

12"



920A/C20X

1 009200950

	○ 920A	10 - 11 - 12 - 13 - 14 - 15 - 16 17 - 18 - 19 - 20 - 21 - 22 - 23 24 - 26 - 27 - 28 - 30 - 32 mm
	920/21	125 mm
	920/22	255 mm
	920/25	
	920/42	
	920/55	
≡ 420x185x60 mm - 5,1 kg		

9899 920C20
Thermoformed tray, empty

1 098990121

920A/C20

1 009200948

	○ 920A	10 - 11 - 12 - 13 - 14 - 15 - 16 17 - 18 - 19 - 20 - 21 - 22 - 23 24 - 26 - 27 - 28 - 30 - 32 mm
	920/21	125 mm
	920/22	255 mm
	920/25	
	920/42	
	920/50	
≡ 420x185x60 mm - 5,1 kg		

9899 920C20
Thermoformed tray, empty

1 098990121

920A/C20Q

1 009200955

	○ 920A	10 - 11 - 12 - 13 - 14 - 15 - 16 17 - 18 - 19 - 20 - 21 - 22 - 23 24 - 26 - 27 - 28 - 30 - 32 mm
	920/21	125 mm
	920/22	255 mm
	920/25	
	920/42	
	920/55Q	
≡ 420x185x60 mm - 5,1 kg		

9899 920C20
Thermoformed tray, empty

1 098990121

920B/C20

1 009200949

	○ 920B	10 - 11 - 12 - 13 - 14 - 15 - 16 17 - 18 - 19 - 20 - 21 - 22 - 23 24 - 26 - 27 - 28 - 30 - 32 mm
	920/21	125 mm
	920/22	255 mm
	920/25	
	920/42	
	920/50	
≡ 420x185x60 mm - 5,0 kg		

9899 920C20
Thermoformed tray, empty

1 098990121



920B/C20X 1 009200951

- 920B 10 - 11 - 12 - 13 - 14 - 15 - 16
17 - 18 - 19 - 20 - 21 - 22 - 23
24 - 26 - 27 - 28 - 30 - 32 mm
 - 920/21 125 mm
 - 920/22 255 mm
 - 920/25
 - 920/42
 - 920/55
- 420x185x60 mm - 5,0 kg

9899 920C20 1 098990121
Thermoformed tray, empty

920.../C21...
21 sockets and 6 accessories



920A/C21 1 009200952

- 920A 10 - 11 - 12 - 13 - 14 - 15 - 16
17 - 18 - 19 - 20 - 21 - 22 - 23
24 - 25 - 26 - 27 - 28 - 30 - 32 mm
 - 920/21 125 mm
 - 920/22 255 mm
 - 920/25
 - 920/42
 - 920/46
 - 920/50
- 420x280x60 mm - 6,5 kg

920A/C21X 1 009200983

- 920A 10 - 11 - 12 - 13 - 14 - 15 - 16
17 - 18 - 19 - 20 - 21 - 22 - 23
24 - 25 - 26 - 27 - 28 - 30 - 32 mm
 - 920/21 125 mm
 - 920/22 255 mm
 - 920/25
 - 920/42
 - 920/46
 - 920/55
- 420x280x60 mm - 6,4 kg

920B/C21 1 009200953

- 920B 10 - 11 - 12 - 13 - 14 - 15 - 16
17 - 18 - 19 - 20 - 21 - 22 - 23
24 - 25 - 26 - 27 - 28 - 30 - 32 mm
 - 920/21 125 mm
 - 920/22 255 mm
 - 920/25
 - 920/42
 - 920/46
 - 920/50
- 420x280x60 mm - 6,4 kg

920B/C21X 1 009200984

- 920B 10 - 11 - 12 - 13 - 14 - 15 - 16
17 - 18 - 19 - 20 - 21 - 22 - 23
24 - 25 - 26 - 27 - 28 - 30 - 32 mm
 - 920/21 125 mm
 - 920/22 255 mm
 - 920/25
 - 920/42
 - 920/46
 - 920/55
- 420x280x60 mm - 6,4 kg

920B/C30Q
30 bi-hex sockets and 5 accessories



920B/C30Q 1 009200975

- 920B 8 - 9 - 10 - 11 - 12 - 13 - 14
15 - 16 - 17 - 18 - 19 - 20 - 21
22 - 23 - 24 - 26 - 27 - 30 mm
 - 920BL 12 - 13 - 14 - 17 - 19 - 21
22 - 24 - 27 - 30 mm
 - 920/21 125 mm
 - 920/22 255 mm
 - 920/25
 - 920/42
 - 920/55Q
- 420x280x60 mm - 7,6 kg



920.../C33
20 sockets, 13 socket drivers
and 5 accessories



920A/C33 1 009200985

- 920A 10 - 11 - 12 - 13 - 14 - 15 - 16
17 - 18 - 19 - 20 - 21 - 22 - 23
24 - 26 - 27 - 28 - 30 - 32 mm
 - 920LP 1,2x8 - 1,6x9 - 2x12 mm
 - ⊕ 920PH PH2 - PH3 - PH4
 - 920PE 4 - 5 - 6 - 8 - 10 - 12 - 14 mm
 - 920/21 125 mm
 - 920/22 255 mm
 - 920/25
 - 920/42
 - 920/55
- 420x280x60 mm - 6,7 kg

920B/C33 1 009200986

- 920B 10 - 11 - 12 - 13 - 14 - 15 - 16
17 - 18 - 19 - 20 - 21 - 22 - 23
24 - 26 - 27 - 28 - 30 - 32 mm
 - 920LP 1,2x8 - 1,6x9 - 2x12 mm
 - ⊕ 920PH PH2 - PH3 - PH4
 - 920PE 4 - 5 - 6 - 8 - 10 - 12 - 14 mm
 - 920/21 125 mm
 - 920/22 255 mm
 - 920/25
 - 920/42
 - 920/55
- 420x280x60 mm - 6,7 kg

920A/C17M - 920A/C17MR

Assortment of 17 hexagon sockets and 5 accessories in foam tray, in metal case

12"



920A/C17M

1 009200924

	920A	10-11-12-13-14-15-16-17-18-19-20-21-22-24-27-30-32 mm
	920/21	125 mm
	920/22	255 mm
	920/25	
	920/42	305 mm
	920/55	

420x185x60 mm - 5 kg

9899 920C17

1 098990137

Soft module, empty

920A/C17MR

1 009200937

	920/21	125 mm
	920/22	255 mm
	920/25	
	920/42	305 mm
	920/58	

420x185x60 mm 5,1 kg

920/C37

37 bi-hex sockets and 5 accessories

12"



920/C37

1 009200988

	920B	10 - 11 - 12 - 13 - 14 - 15 - 16 17 - 18 - 19 - 20 - 21 - 22 - 23 24 - 26 - 27 - 28 - 30 - 32 mm
	920AS	3/8 - 7/16 - 1/2 - 9/16 - 19/32 5/8 - 11/16 - 3/4 - 25/32 - 13/16 7/8 - 15/16 - 1 - 1.1/16 - 1.1/8 1.3/16 - 1.1/4
	920/21	125 mm
	920/22	255 mm
	920/25	
	920/42	
	920/55	

420x280x60 mm - 7,5 kg

920AS/C10

10 bi-hex sockets and 2 accessories

12"



920AS/C10

1 009200919

	920AS	3/8 - 7/16 - 1/2 - 9/16 - 5/8 11/16 - 3/4 - 13/16 - 7/8 - 15/16
	920/22	255 mm
	920/50	

335x145x60 mm - 2,6 kg

920AS/C15

15 bi-hex sockets and 6 accessories

12"



920AS/C15

1 009200947

	920AS	3/8 - 7/16 - 1/2 - 9/16 - 5/8 - 11/16 3/4 - 13/16 - 7/8 - 15/16 - 1 1.1/16 - 1.1/8 - 1.3/16 - 1.1/4
	920/21	125 mm
	920/22	255 mm
	920/25	
	920/42	
	920/46	
	920/50	

420x280x60 mm - 5,9 kg



920AS/C17X

17 bi-hex sockets and 5 accessories

12"



920AS/C17X

1 009200942

	920AS	3/8 - 7/16 - 1/2 - 9/16 - 19/32 - 5/8 11/16 - 3/4 - 25/32 - 13/16 - 7/8 15/16 - 1 - 1.1/16 - 1.1/8 - 1.3/16 - 1.1/4
	920/21	125 mm
	920/22	255 mm
	920/25	
	920/42	
	920/55	

420x185x60 mm - 4,8 kg

920AS/MBM-C21

16 bi-hex sockets and 5 accessories for aeronautical maintenance

12"



920AS/MBM-C21

1 009200944

	920AS	3/8 - 7/16 - 1/2 - 9/16 19/32 - 5/8 - 11/16 - 3/4 25/32 - 13/16 - 7/8 - 15/16 1 - 1.1/16 - 1.3/16 - 1.1/4
	920M/55	
	920/21	125 mm
	920/22	255 mm
	920/25	
	920/42	

420x185x60 mm - 5,0 kg



920TX/C17

6 bits, 6 sockets, 5 socket drivers and 4 accessories for Torx® head screws



920TX/C17 1 009200989

	861TX	T8 - T10 - T15 - T20 - T25 - T27
	897	
	920TX	T27 - T30 - T40 - T45 - T50
	920FTX	E10 - E12 - E14 - E16 - E18 - E20
	920/20	75 mm
	920/22	255 mm
	920/55	
		420x185x60 mm - 2,9 kg

920A/C17HR

17 hexagon sockets and 5 accessories in hard foam tray, in metal case

• ratchet with rotating handle



920A/C17HR 1 009200939

	920A	10-11-12-13-14-15-16-17-18-19-20-21-22-24-27-30-32 mm
	920/21	125 mm
	920/22	255 mm
	920/25	
	920/42	
	920/58	
		420x185x60 mm - 5,1 kg

920U/C17M

17 gear lock hand sockets and 5 accessories, in soft foam tray



920U/C17M 1 009201797

	920U	<ul style="list-style-type: none"> ○ 10-11-12-13-14-15-16-17-18-19-20-21-22-24-27-30-32 mm * 3/8-7/16-15/32-1/2-9/16-19/32-5/8-3/4-25/32-7/8-15/16-1.1/16-1.1/8-1.1/4 ○ M12-M14-M16-M18 ○ E12-E14-E16-E18-E20-E22-E24
	920/21	125 mm
	920/22	255 mm
	920/25	
	920/42	305 mm
	920/55	275 mm
		420x185x60 mm - 5 kg

9899 920C17 1 098990137
Soft module, empty

928A

hexagon hand sockets



UNI/ISO 2725
DIN 3124

mm	Ø mm	L mm	Ø1 mm		
19	29,2	50	34	5	009280019
21	30,0	51	34	5	009280021
22	31,3	53	34	5	009280022
23	33,3	53	34	5	009280023
24	34,5	53	34	5	009280024
26	36,8	55	35	5	009280026
27	38,0	56	35	5	009280027
28	39,0	57	35	3	009280028
29	40,2	58	35	3	009280029
30	41,5	58	37	3	009280030
32	44,3	60	37	3	009280032
33	45,8	60	37	3	009280033
34	46,8	60	37	3	009280034
35	48,1	62	38	3	009280035
36	49,5	64	38	3	009280036
38	52,0	68	40	3	009280038
41	56,0	71	40	3	009280041
46	62,3	75	43	3	009280046
50	67,4	80	43	3	009280050
55	73,7	84	48	1	009280055
60	80,0	87	48	1	009280060

928B

bi-hex hand sockets



UNI/ISO 2725
DIN 3124

mm	Ø mm	L mm	Ø1 mm		
19	29,2	50	34	5	009280119
21	30,0	51	34	5	009280121
22	31,3	53	34	5	009280122
23	33,3	53	34	5	009280123
24	34,5	53	34	5	009280124
26	36,8	55	35	5	009280126
27	38,0	56	35	5	009280127
28	39,0	57	35	3	009280128
29	40,2	58	35	3	009280129
30	41,5	58	37	3	009280130
32	44,3	60	37	3	009280132
33	45,8	60	37	3	009280133
34	46,8	60	37	3	009280134
35	48,1	62	38	3	009280135
36	49,5	64	38	3	009280136
38	52,0	68	40	3	009280138
41	56,0	71	40	3	009280141
46	62,3	75	43	3	009280146
50	67,4	80	43	3	009280150
55	73,7	84	48	1	009280155
60	80,0	87	48	1	009280160

928AS

hexagon hand sockets



mm	Ø mm	L mm	Ø1 mm		
7/8	32,0	53	34	1	009280202
15/16	34,5	53	34	1	009280203
1	36,2	55	35	1	009280204
1.1/16	38,0	56	35	1	009280205
1.1/8	40,2	58	35	1	009280206
1.1/4	44,2	60	37	1	009280208
1.5/16	45,8	60	37	1	009280209
1.3/8	48,1	62	38	1	009280210
1.7/16	49,5	64	38	1	009280211
1.1/2	52,0	68	40	1	009280212
1.5/8	56,0	71	40	1	009280214
1.11/16	58,8	74	40	1	009280215
1.13/16	62,3	75	43	1	009280217
1.7/8	65,0	78	43	1	009280218
2	68,3	80	43	1	009280219
2.1/16	71,5	83	48	1	009280220

928ME

socket drivers for hexagon screws

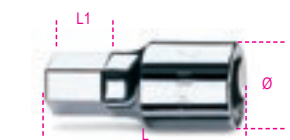

mm	Ø mm	L mm	L1 mm		
14	35	75	15,5	2	009280514
17	35	75	15,5	2	009280517
19	35	75	15,5	2	009280519
22	35	75	22,5	2	009280522

928/15

adaptor, 3/4" female and 1/2" male drives



UNI/ISO 3316
DIN 3123

L	Ø	□	■	Icon	Icon
mm	mm				
51,5	34	3/4	1/2	5	009280801

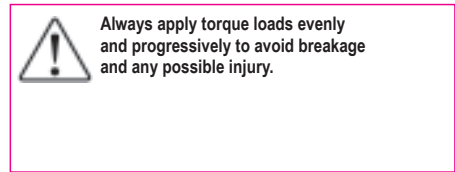

928/16

adaptor, 3/4" female and 1" male drives



UNI/ISO 3316
DIN 3123

L	Ø	□	■	Icon	Icon
mm	mm				
65	34	3/4	1"	5	009280807

928/20 - 928/21 - 928/22

3/4" drive extension bars

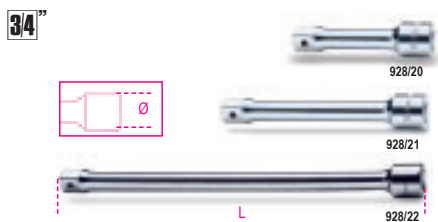

UNI/ISO 3316
DIN 3123

	L	Ø	Icon	Icon
	mm	mm		
928/20	100	34	3	009280810
928/21	200	34	3	009280815
928/22	380	34	3	009280825

928/25

3/4" drive universal joint



UNI/ISO 3316 DIN 3123

L	Ø	Icon	Icon
mm	mm		
108	40	1	009280830

928/36A

3/4" drive swivel handle



DIN 3122 - UNI ISO 3315

L	Icon	Icon
mm		
545	1	009280844

928/42

3/4" drive slide T-handle

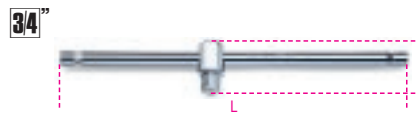

UNI/ISO 3315 DIN 3122

L	A	Icon	Icon
mm	mm		
450	62,5	3	009280850

928/55

3/4" drive reversible ratchet, 72 teeth



DIN 3122 - UNI ISO 3315

L	Ø	A	Icon	Icon
mm	mm	mm		
510	58	59	2	009280862

Spare parts
rotating mechanism of ratchets,
see table after item 929/C8

928.../C12

assortment of 12 hexagon hand sockets and 5 accessories in sheet metal case



928A/C12 1 009280955

Icon	Ø	L	Icon	Icon
	mm	mm		
928A	22 - 24 - 27 - 30 - 32 - 34 - 36	38 - 41 - 46 - 50 - 55 mm		
928/21	200 mm			
928/22	380 mm			
928/25				
928/42				
928/55				

530x220x80 mm - 13,5 kg

928B/C12

1 009280957

Icon	Ø	L	Icon	Icon
	mm	mm		
928B	22 - 24 - 27 - 30 - 32 - 34 - 36	38 - 41 - 46 - 50 - 55 mm		
928/21	200 mm			
928/22	380 mm			
928/25				
928/42				
928/55				

530x220x80 mm - 13,5 kg

928AS/C12

assortment of 12 hexagon hand sockets and 5 accessories in sheet metal case



928AS/C12

1 009280968

Icon	Ø	L	Icon	Icon
	mm	mm		
928AS	7/8-15/16-1.1/16-1.1/8-1.1/4	1.5/16-1.7/16-1.1/2-1.11/16		
928/21	200 mm			
928/22	380 mm			
928/25				
928/42				
928/55				

530x220x80 mm - 13,5 kg

929

hexagon hand sockets

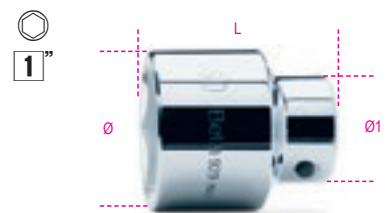

UNI/ISO 2725 DIN 3124

Icon	Ø	L	Ø1	Icon	Icon
mm	mm	mm	mm		
36	51	65	48	1	009290036
41	57	70	48	1	009290041
46	65	75	48	1	009290046
50	70	80	48	1	009290050
55	76	85	54	1	009290055
60	82	90	54	1	009290060
65	88	95	54	1	009290065
70	92	100	60	1	009290070
75	99	110	60	1	009290075
80	106	120	60	1	009290080

929/15

adaptor, 1" female and 3/4" male drives

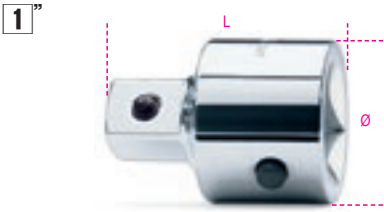

UNI/ISO 3316 DIN 3123

L	Ø	□	■	
mm	mm	1"	3/4"	
65	47			2 009290801



Always apply torque loads evenly and progressively to avoid breakage and any possible injury.

929/21 - 929/22

1" drive extension bars



UNI/ISO 3316 DIN 3123

	L	Ø	
	mm	mm	
929/21	200	47	1 009290815
929/22	400	47	1 009290825

929/42

1" drive slide T-handle

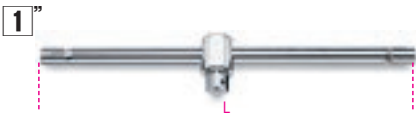

UNI/ISO 3315 DIN 3122

L	
mm	
535	1 009290850

929/55

1" reversible ratchet 72 teeth



UNI/ISO 3315 DIN 3122

L	Ø	A
mm	mm	mm
770	62	63

929/55PR

extension bars for ratchets 929/55



L	Ø	Ø1	
mm	mm	mm	
540	32	26	1 009290868

929/C8

8 hexagon sockets and 5 accessories



929/C8

	929	46 - 50 - 55 - 60 - 65 70 - 75 - 80 mm
	929/15	□ 1" - ■ 3/4"
	929/21	200 mm
	929/22	400 mm
	929/42	
	929/55	

560x290x120 mm - 29 kg

9899 CV/A

empty case



9899 CV/A

583/C31-671B/C5-671B/C10-720ME/C8-860/C38P
861/C61P-900/C11-900AS/C10-/MB-C17-900/C24
900/C13-8-900/C13-5-900MB/C19-900MB/C28
900/C11HR-900AS/C10-/MB-C17-900AS/C17
MBM-900/C11Z-900MC/C24-900MC/C32-910.../C10
971/C8-920TX/C-920PE/C-920FTX/C-910.../C10

270x120x45 mm

9899 CV/B

empty case



9899 CV/B

352C/U-720MC/C13-727/C16-867/C20
900/C12MR-900/C12MZ-900U/C12M-910AS/C13...
910AS/MBM-C18-910A/C16...-910B/C16...
910A/C16HR-910A/C16...-910B/C16...-920AS/C10
920.../C11-1433/C11-1494/C14A-1529-1545/C5M

335x145x60 mm

9899 CV/C

empty case



9899 CV/C

920A/C17HR-920A/C17MR-920.../C12...
920A/C17M-910.../C29-902A/C22-867/C38
720/C24-450/C15-353N/C6-960KPC-920MC/C14
920U/C17M-920TX/C17-920.../C20...-920AS/MBM
C21-920AS/C17X-1547/C6-1495/C6-1489/C14
1461/C11A-1608/C9-1606A/C9-1602/C9

420x185x60 mm

900/R55



900/R55

666N/2-900/55-666/2

900/R55-Z



900/R55-Z

900M/R55



900M/R55
900M/55

910/R55

3/8"
7/2



910/R55
599DGT/6-606/6-606/10-612
665/6-665/10-665LB/6-665LB/10
666N/5-666N/10-666N LBF.IN/5-
666N LBF.IN/10
666/6-666/10-668RGC/6-
668RGC/10-910/55
666/5-666HS/5-666HS/10-666 LBF.FT/2
666 LBF.FT/5-666 LBF.FT/10

1 009100879

910M/R55

3/8"



910M/R55
910M/55-910M/56

1 009100888

910/R55Q

3/8"
4/8



910/R55Q
910/55Q

1 009100877

910/R55X

3/8"
4/8



910/R55X
666N/2X-666/2X-666 LBF.FT/2X

1 009100897

920/R50

1/2"
7/2



920/R50
614/50-667/20-667/30
667N/20-667N/30-920/50

1 009200866

920/R55

1/2"
7/2



920/R55
606/20-606/30-666/20-666/30-920/55
920/56A- 599DGT/20-599DGT/30
599DGT-AN/20-665/20-665/30-665LB/20
665LB/30-666N/20-666N/30
666N LBF.IN/20-666N LBF.IN/30-668RGC/20
666 LBF.FT/20-666 LBF.FT/30

1 009200879

920M/R55

1/2"



920M/R55
920M/55-920M/56

1 009200888

920/R55Q

1/2"
4/8



920/R55Q
920/55Q

1 009200877

920/R55X

1/2"
7/2



920/R55X
606/10X-612X
666/10X-920/55X-599DGT/10X-599DGT-
AN/10
665/10X-665LB/10X-666N10X-
666N LBF.IN/10X
668RGC/10X-666 LBF.FT/10X
666HS/20LC-666HS/30LC

1 009200878

920/R55LC

1/2"
7/2



920/R55LC
920/55LC "Locking System"

1 009200887

928/R55

3/4"
7/2



928/R55
928/55

1 009280859

928/R55X

3/4"
7/2



928/R55X
614X

1 009280858

929/R55

1"
7/2



929/R55
929/55

1 009290859

930

double ended bi-hex tubular socket wrenches,
heavy series



UNI 6745

mm	L	Ø	Ø1		
mm	mm	mm	mm		
6x7	100	9,5	11,0	3	009300006
8x9	108	12,5	14,0	3	009300010
10x11	116	15,0	16,5	3	009300014
12x13	124	17,5	19,0	3	009300018
14x15	132	20,0	21,5	3	009300023
16x17	140	23,0	24,0	3	009300027
18x19	148	25,0	26,5	3	009300032
20x22	156	28,0	30,0	2	009300036
21x23	163	29,0	31,5	2	009300040
24x26	173	33,0	35,5	2	009300044
25x28	182	34,5	38,0	2	009300048
27x29	191	37,0	39,5	2	009300052
30x32	200	40,5	43,0	2	009300056



930/S8 1 009300081

6x7-8x9-10x11
12x13-14x15-16x17
18x19-20x22 mm

940/1 - /2

930/S13 1 009300083

6x7-8x9-10x11-12x13
14x15-16x17-18x19
20x22-21x23-24x26
25x28-27x29-30x32 mm

940/1 - /2 - /3



930/C13 1 009300098

6x7-8x9-10x11-12x13
14x15-16x17-18x19
20x22-21x23-24x26
25x28-27x29-30x32 mm

940/1 - /2 - /3